

# Model Radio Control CARS

ISSUE No. 6

Price 50p. \$1.50 (US) DM3.50

SIX ISSUES PER ANNUM

Fr. F6.00 Gir.3.50 Sw. Fr.3.00

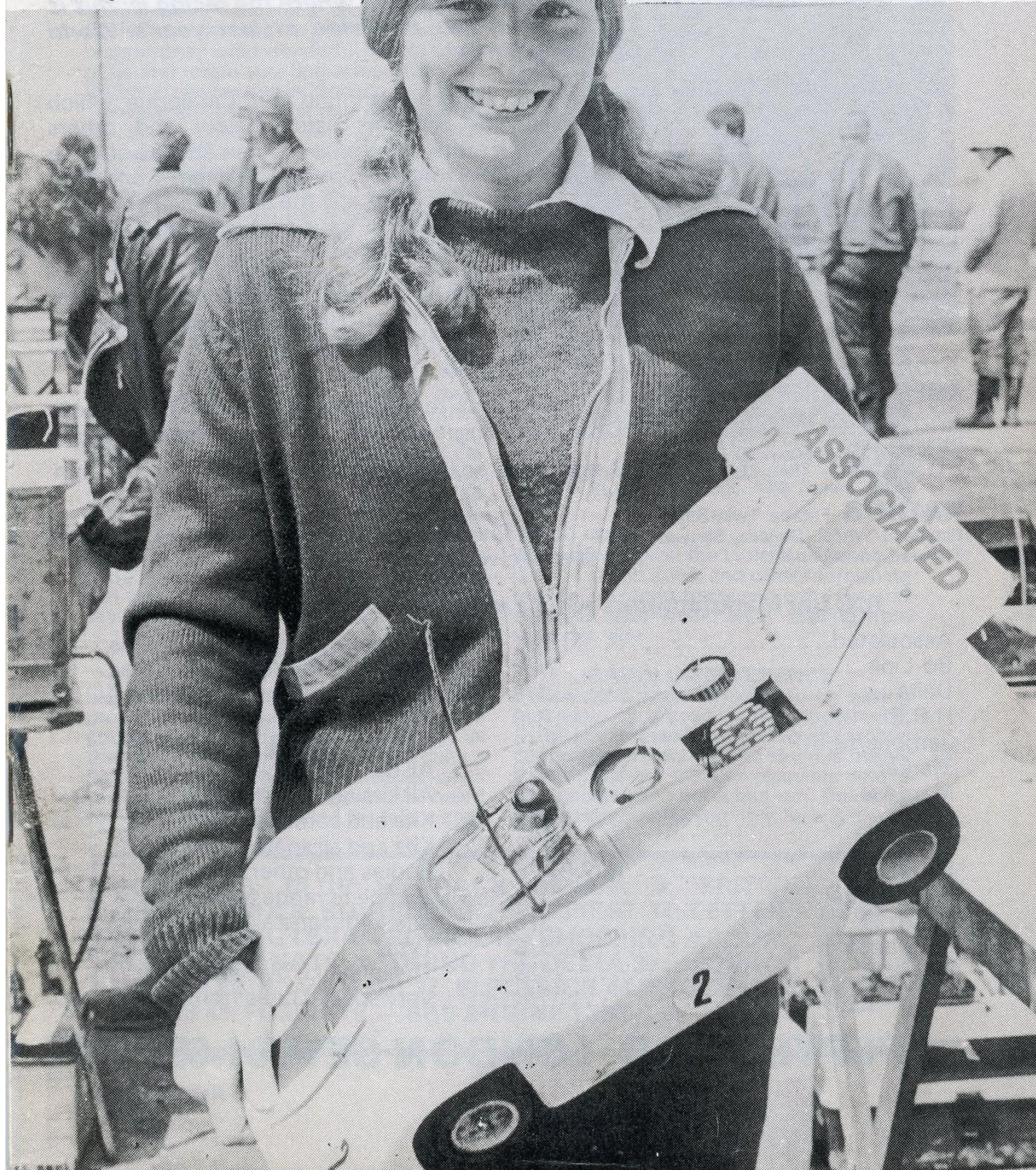





# R/C Ted Longshaw for Service & Experience

*You will always find me where the racing is: this is a shot from the trackside at last year's World Champs in U.S.A.*

Once again we are reprinting our Catalogue which covers all the products listed below and others besides. With more stock mixture than anyone else we know you should get a copy for yourself. Send 50p. (though much bigger it is still the same price and even this cost is refunded on your first purchase) to our MAIL ORDER ADDRESS below.

**NORMALLY MAIL ORDER ONLY** but we also have a Showroom near Biggin Hill that can be visited by appointment at practically any time — Tel: 0689 (London 66) 55313.

We also have all the accessories needed by R/C car drivers, including tyres from all major manufacturers.

1/8 and 1/12 scale bodies from America, G.B. and Italy.

If you don't find what you want in our catalogue, drop us a line. We've probably got it anyway.

## Stop Press! Latest! AMPS DIFFERENTIAL UNIT

comp. with rear mounting blocks, bearings, disc. ready to go straight on PB International

**£42.95**

**RADIOS** Futaba Twin-Stick, Futaba S/Wheel, Digiace, Sanwa, Trigger Conversion Kit.

### R/C Car Manufacturers whose products are normally ex stock:

Associated .....	Complete range and all spares
Bo-Link .....	Complete range and all spares
Delta .....	1/12 Complete range and all spares
H.R.E. ....	1/8 Kit by Chuck Hallum
H.R.E. ....	1/8 Kits and spares
Jerobee/M.R.P. ....	1/12 All parts in stock
Marker .....	1/8 All kits and most spares
Mardave .....	1/8 Kits and some spares
Mardave .....	1/12 Kits and all spares
Letricar .....	1/12 Bodies and other goodies
Parma .....	1/12 & 1/8 Complete range and spares
P.B. Products .....	1/8 Kits, diffs. and all spares
Thorp .....	1/8 Tyres
Ultimara .....	1/8 The latest kit by Sabbo
S.G. Italy .....	1/8 Very special tyres from Switzerland
U.F.R.A. ....	1/8

**80 PEPYS ROAD, LONDON SE14 01-639 5080**

# radio control MODEL CARS

Published by L-D EDITORIAL — TECHNICAL SERVICES LTD., P.O. Box 30, HEMEL HEMPSTEAD, HERTS. HP1 1NL. JULY 1978.

Editor: "Dickie"  
Laidlaw-Dickson

## THE WONDERFUL BRITISH . . .

I READ somewhere . . . or someone said . . . that the British habit of modesty about their own achievements is a commercially dangerous character trend. So let's be thoroughly un-British just for once and say what wonderful people some of us are! Inside you find a report on our British achievements in Monaco — a clear "whitewash" of the first four places, three of them achieved with the British produced PB International as the basic car plus the leading Italian (Stanzani) also driving a PB International. Additionally, two of the cars had the British designed, developed and conceived AMPS differential fitted, whilst Keith Plested's car had his own PB differential following a different line of development and shortly to come on the market.

On another tack Ron Irvine is developing the Irvine engine for model cars, and I have just had an opportunity of going over his works and seeing them coming off the delivery lines in their hundreds, all made with British labour and British skill. Again, the development of the 1/12 electric car in this country has been manifestly a British effort by Mardave and Letricar . . . only now the market is wide open are other makes flooding in from overseas.

So, in our little world of model cars let's just stop being modest and go right ahead saying British is best and really meaning it.

## CONTEST REPORTS

At this time of the year things are happening like mad so that a high proportion of space must be devoted to contest reports. These will be as newsy as they can be made but must contain quite a lot of names that make no particular news to a lot of us though we may later be heard to say, oh yes, we spotted his talent ages



See there it is again! PB International on front cover of Dutch HB Hobby Bulletin — see the windmill in the background, with feature article inside.

ago when he won the Little Muddelcombe G.P. . . . Club Secs. and others furnishing reports are urged to try and write the sort of report they would enjoy reading from someone else.

## RADIO INTERFERENCE

More and more we seem to be having problems of alleged radio interference. Some say it must be caused by sunspots; contest organisers tend to say it is mainly clottishness by the complainants and a jolly good excuse for a bad run. But there is certainly something that needs to be

**CONTENTS: CLUB & TRACK REVIEW 6: BRITISH GRAND PRIX 8: BOURNEMOUTH'S FIRST 12: LETTERS 13: PAINTING LEXAN BODIES 19: SHOPPING AROUND 21: BRITISH NATS 24: DOING THE DELTA 30: MONACO WORLD CUP 1-2-3-4 GB 37: ELECTRICS 44: STOCK CAR NOTES 48: FUJI 19-IV — SBB ENGINE TEST**

**6**



done. Certain areas are notoriously bad either because of adjacent metalwork, harmonics from traffic lights, hospitals with doctor-calling devices nearby and so on. Deep down there is the thought that whilst we are all rapidly moving up in style with the latest this and that in the car we are not quite so kind to our poor old radio gear. Once we kept it all in a neat little plastic box, now it is lucky to get covered by an old plastic bag that the bellhousing came in. Filthy dirty, covered with oil and tyre dust, frayed wires, dry joints and we expect it to work. Along comes a gentleman with new equipment clean and decent (it won't be for long!) and indignant operators claim he is swamping their frequency! I do wish the radio boffins (hear that Jeff Lindstrom?) would get together and sort out these problems . . . the very least I ask for is a really good article from one of them on the care and treatment of radio equipment . . . but soon, Lord, soon as the old spinster asked when praying for a husband!

#### BINDERS ARE IN . . . OR SHOULD BE . . .

As we go to press first of our binders should be going out as delivery was promised for June 23rd. We included a firm price and an order form in the insert to Issue No. 5 with the Monaco GP Forecast Contest on it. Response was splendid and will go a long way to paying for the first batch almost before we have them. To reiterate the binders cost £2.75 for home readers, £3.25 for overseas readers and will be forwarded in special protective packing direct from the manufacturers using labels we shall supply. Bound in red balacron (a strong leatherlike covering) with gold coloured title on spine they are the typical Easibind type of binder which does not mark or damage copies and they will hold twelve issues or a two year run. Just send me the money, I'll do the rest.

#### GERMAN REPRESENTATION

I embarked on arrangements for the magazine to be distributed in Western Germany and in German speaking countries adjacent with high hopes that this would smooth a growing interest from those parts by providing a speedy and local service plus an inserted summary in German. Alas, this has not proved a good idea. Traders tell me they have received no copies at all, although I transferred such trade orders to the German distributor.

Readers told me that they had only received their No. 4 issues when No. 5 was already in circulation here. No doubt my distributor took on the job in all good faith but did not realise that magazine distribution is a specialist skilled job taking up much time and energy, whilst technical translation even into one's mother tongue is a highly tricky job. I know, I do some! Added to all this is the cash flow side of prompt — or unprompt — settlement! Any German subscribers who have not received their copies should send me a Xerox of their subscription receipt and I will honour their subscriptions from England (though not with a German language summary). Those German companies who had ordered direct from me initially may resume supplies from England as they may wish.

#### FAMILY RACING TEAMS

Reader John White of Hedge End Southampton has come up with a splendid young entry/c car team with self and son aged eight. Here is a picture of Dad and Junior with their equipment. Son has mainly been winning with his stock car but is now moving up to the big stuff with his eye on Sports/GT. Meanwhile Mrs. Roberta Moody has sent in a list of no less than sixteen contenders from U.S.A. Space does not permit listing them all just now but notables are Ken and Georgia Campbell from Lorimor (the Delta people) and for quantity there is Steve and Yvette Schubert and son Tom from Calumet City, Indiana; Robert and sons John and Mike Topolski C.R.C.C. Roberta adds: "These wives are **drivers** not just pitworkers. Many times they are better drivers. At the Mini-Oval-Indy three wives qualified when their husbands did not make it (Rita Robertson, Linda Schulte and Georgia Campbell)."

#### MONACO COUPE DU MONDE FORECAST WINNERS

Quite up to expectations no one got an all correct result! Nearly a hundred and fifty people tried their hand at it but nearest shot was five out of eight: then followed four more entries with four correct finalists. These latter four were all capable of being placed in order by the nearest they got to the right order. The non-winning pair of these four will receive binders as consolation prizes. Here are their names and districts with the names they chose:

Winner: D. Brader, 61 Rasen Lane, Lincoln (Wins Associated RC100 kit from Ted Longshaw Models).

Second: D. R. F. Hull, 1 Bath Close, Wyton, Cambs (Wins PB7 International Kit from Keith Pledsted of PB Products).

Third: A. Pierce Jones, 14 Lon Alun, Colomendy (Wins a Veco 19 from Phil Greeno Models).

Fourth: Keith Payne, 79 Sketchley Road, Burbage (Wins Binder from RC Model Cars).

Fifth: Tom Martin, 7 The Green Werrington (Wins Binder from RC Model Cars).

Forecast: Thorp PLESTED Gustafsson GREENO TON PRESTON BERVOETS Husting.

Forecast: Bevacqua GREENO Olssen BOOTH PLESTED Sabbattini TON Kroell.

Forecast: PLESTED GREENO Husting Martin Sabbattini TON BOOTH Curtis.

Forecast: Thorp PLESTED TON BERVOETS Husting Gustafsson Bevacqua GREENO.

Forecast: Martin Gustafsson Jianas TON Curtis BOOTH PLESTED GHERSI.

#### BACK NUMBERS PROBLEMS

Issues numbered 2, 3 and 4, plus by the time the magazine appears, number 5, are all sold out! I view this with mixed feelings. Joy, naturally at having no dead stock to carry, but regret that readers coming late cannot start from the beginning. What I propose to do is to re-issue in book form all those articles which deal with making or running cars, both 1/8th scale and electric, modified as may be necessary in the light of current experience and with club addresses, tracks, governing bodies, rules and regulations. This should be published under a progressive title such as: Radio Control Model Cars Manual No. 1 . . . Hopefully this should be ready for the Christmas market at an approximate price of £2.50 for at least 128 pages same size as the mag, square backed, with drawn on cover.

#### YEAR ONE

Well, this completes the first year's issues with Number 6. It has been hard but highly enjoyable work for me. Reception has been most encouraging and as the hobby grows the magazine is extending its range — it goes into every English speaking country and every country in

Europe (not true — no subscribers yet from Andorra!) A large firm of magazine exporters is sending now to Southern Africa and I hope that satisfactory arrangements can be made to service Belgium, Holland and France in the near future. Thank you supporters, one and all.

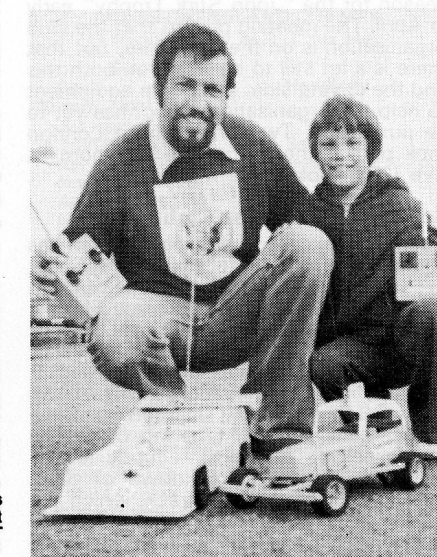

Reader John White with White Junior who is already making a name as a stock car driver at eight years of age: but with an eye on dad's Sports/GT for the very near future.



# CLUB & TRACK REVIEW

## Mardave Owners' Club

MARDAVE Owners' Club will be holding the Newbridge Grand Prix for F1 cars on September 17th, start time 10.0 a.m. when it is hoped to raise some money for charity by you, the driver getting friends, relations, companies, etc. to sponsor you on the number of laps you complete over four races. Each driver will have four **12 minute** races with the best three to count towards class wins. Our three class system will apply, with trophies awarded to the two drivers in each class with the highest lap totals. A trophy will also be awarded to the driver collecting the most sponsorship money. This format will give everyone **48 minutes** of racing time for £1 entry fee, which will also be given to charity.

This is a pre-entry meeting with a limit of 36 drivers and a closing date of August 20th. Entry form and sponsorship sheet will be sent on request (enclosing SAE) to: Stewart J. Busby, 72 Rosamund Avenue, Narborough Road South, LEICESTER.

## Keighley and District M.E.S. R/C Stock Car Section

Secretary: J. M. Varley  
10 Briarwood Avenue  
Riddlesden  
Keighley, Yorks.

Please note change of secretary for Stock Car Section (vice P. Humphrey). The society held its first meeting of the season for the "John Stirk Trophy" early in April. The meeting proved that the club organisation is on the right lines, but that there is a lot still to be learnt on both this and the driving side. Adequate equipment to help the organisation aspect has yet to be purchased. Two drivers from London took part in the event, one of whom R. Bye (258) took home the trophy.

## Southern Radio Car Club

Another excellent club news letter has come through the letterbox — The Stock Exchange, produced by the Southern Radio Car Club by editor Mervyn Phillips. First item of interest is almost doubling of club number from twenty to a new total of 36, plus several others "on the verge." It contains lots of meeting reports, news items such as delay in getting Enya replacement parts (a time lag of over a year is noted), cartoons — funny too — and a most useful breakdown of parts used in making the club track, which are worth passing on: Size: Length 110ft. (scaled up exactly 1/6th of a mile) Length

of straights: 29ft. 10ins. Inner track radius 8ft. Track width 8 — 9ft. Materials: Timber 180ft. of 6in. x 1in. 128ft. 3 1/2in. by 1/2in. Hardboard 1 sht 6 1/2ft. x 8ft. Sheet steel 1 sht. 4ft. square. Plastic pipe 208ft. Paint 3 1/2 gallons. Glue 1/2 litre. Nuts and bolts 20 sets. Hinges 52. Woodscrews 1,128. Total cost £30.10 (just try getting the timber alone for under £50! This shows what co-operative effort can do — knowing kind friends in the trade, etc. so no club should ever despair of getting a track going with the right will).

## Taunton Radio Auto Klub (TRAK)

Chairman: Mike Lewis  
3 Longmead Close  
Hoveland Park. Tel: Taunton 85543  
Taunton Somerset.

The club was formed a year ago and race 1/8th scale Formula, Saloon and Sports/GT cars. Although membership growth has been slow interest is steadily increasing. Further static window displays and Fete demonstrations have been arranged and will give effective publicity to the club's activities.

Thursday evening championship events are held at a local Youth Centre (with floodlighting!) and a small twisty track layout is dictated by the 38 x 35 yards area available. For the Sunday afternoon events a large car park is used by permission of the local council, and this enables a marked 280 yards lap circuit to be used with long straights between hairpin bends and twisty sections.

There is a great variety of cars, ranging from PB Internationals and Experts to Associated RC 100s and Mardave. An even greater variety of motors is in evidence from Veco 19s — Vecoys — Fuji — to STX 21s. Inter club events are held with Torbay and Exmouth clubs and members, of course, visit the purpose built circuit at Mendip for class competition.

## Canterbury R/C Model Car Club

Secretary: Derek Smith  
7 Lenham Road,  
Platts Heath  
Lenham, Kent ME17 2NX

Formed over a year ago, the club suffered a nomadic existence due to lack of permanent track availability. Now a 158 yard track has been marked out on a public car park on the Wincheap Industrial Estate at Canterbury. Racing takes place every Sunday afternoon. Fastest lap to date is 15 seconds or 421.55 m.p.h. Membership stands at fifteen at present; more would be welcome.

## Derby R/C Model Car Club

Secretary: B. R. Phelan  
18 Chelwood Road,  
Chellaston  
Derby

Club was formed in February this year, and is affiliated to the Derby Sports Centre on whose disused car park the club circuit is situated. Meetings take place every Saturday afternoon. Arrangements are under way for a change of track due to noise complaints from very adjacent houses. Membership started with a small nucleus but is growing steadily. New members very welcome and interested parties should contact secretary.

## Northavon Model Auto Club

We are happy to report that young Mark Burrell who has been organising a club mainly for electric 1/12th scale cars has now made contact with the above club whose Chairman John Beddis invited him along to the club meeting. As a result his efforts have been consolidated into an Electric Car Section for Northavon. This is a splendid move that brings two related local efforts under one strong banner to the benefit of both groups. Already there is every prospect of the club starting its own news letter and generally expanding its activities. The Bristol area seems to be developing into a hive of r/c car activity . . . could it just possibly be due to the presence of that purpose built track at Mendip?

## Stafford, Stone and Uttoxeter

Clive Bower, "Elford Rise", Elford Heath, Eccleshall, Stafford, ST21 6JB (Tel: Eccleshall 850482 Std code 0785) is interested in forming a club to serve the above areas. A number of sites are under consideration, the main one being an old aircraft runway. The club also hopes to race 1/8th scale dragsters if enough enthusiasm can be aroused. Potential members should get in touch with Clive as above.

## Tibshelf R.C.R.C.C.

Rotherham and District Arts Council is organising a "Festival of Modelling" from 23rd September to 1st October 1978 in the Arts Centre, Rotherham and I am trying to organise a display/race meeting for 1/12th scale electric cars on 30th September and 1st October. Would any readers who are interested in attending/racing please contact organiser: Phil Maxfield, 40 The Brow, Brecks, Rotherham, S. Yorks. Tel. Wickersley 5055.

## Maidenhead M.M.C.

Hon. Sec.: P. Brown Treasurer: R. Price

The club originally goes back to cable racing days but the current group was started about 2 1/2 years ago in a school playground and then moved to White Waltham Airfield in early 1977. The circuit is L shaped with an S bend on the right angle and a chicane on the upright. Cars drive clockwise, though for no particular reason. Surface is concrete, being part of the perimeter track. The future of the entire airfield has been in doubt for many years but that has recently changed and negotiations are underway for a new circuit on virgin land a few hundred yards away, together with a few of life's little luxuries including "ablooshuns."

Membership is of now 26 and rising. The majority of cars being X21 powered Internationals, but that does not mean that Vecos are unwelcome. Everyone indeed is welcome. Sunday is the popular day, especially after lunch when the streets are aired. The club is now into electric as well, as this has been posing a problem. Racing takes place indoors in what could be described as an ideal environment. Light and air-conditioned, a bar, a 600-seat grandstand cum pit area and rostrum and a slippery floor the size of two tennis courts. Most of the problems seem to have cracked now so if anyone is interested then telephone Roy Price on Maidenhead 37295, where they can hear the where, when, how much and what with.

## SOUTH OF ENGLAND CHAMPS

At Mendip 29/30 April — 1st May

Saloons		Handicap
<b>Open</b>		
<b>30 min. final</b>		
Jim Harrop	73 laps	
• John Beddis	65	Same result
Ray Lemin	59	as
Pete Young	51	open
Andrew Hale	38	final
Nigel Bathe	29	
<b>Formula</b>		
<b>30 min. final</b>		
• K. Pleased	87 laps	Glyn Allen
Steve White	83	Ray Lemin
Gary Culver	83	Fred Martin
Bob Errington	83	Jim Harrop
Colin Englandfield	80	Malcolm Bartlett
Paul Padgin	65	Dave Jones
<b>Sports/GT</b>		
<b>20 min. final due to rain</b>		• F-T-D
• Paul Padgin	64 laps	Terry Gane
Keith Pleased	61	Andrew Hale
Bob Errington	60	Glyn Allen
John Beddis	58	Pete Young
Pete Hutton	55	Jim Harrop
Gary Culver	51	Dave Jones



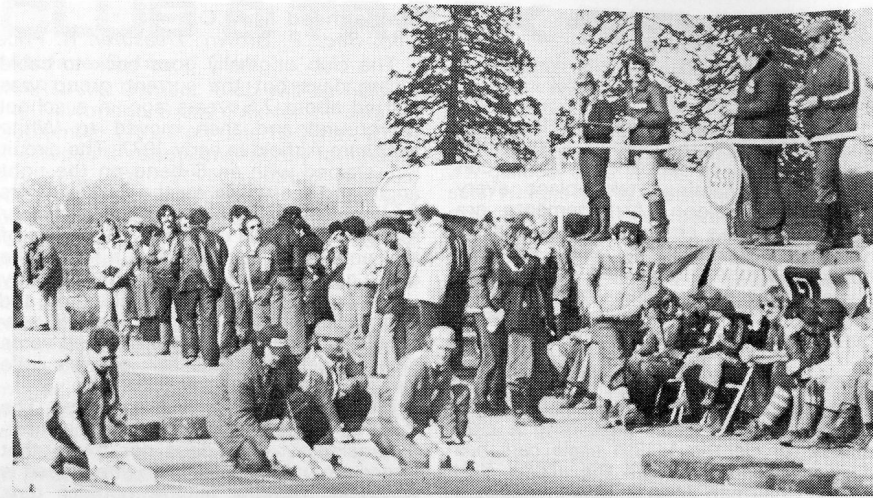

## BRITISH GRAND PRIX AT LILFORD PARK

EARLY arrivals at Lilford Park on the Friday evening had every reason to feel despondent with a steady downpour, gumboot weather (sold out in nearby Thrapston by Saturday midday they say!) and of course the covered pits still uncovered from the earlier storms! Caravans parked where they could get without great regard for pretty parking and practice was zero. Saturday dawn saw a drying track from about 7 a.m. and stalwarts got started . . . squelch squelch . . .

It says much for everyone's resiliency that by midday with a drying track surface everyone, or nearly everyone, was knuckling down to it: those from foreign shores who had brought sunshades erected them as umbrellas.

The newly added circuit extensions were reported as somewhat bumpy and with a different surface and drying time from the original area provided some problems in tyre wear. A good contingent of visitors from Holland, with Ronnie Ton and Peter Bervoets, Belgium with Dennis Tassaux in good strength, Cronberg from Denmark and Alfred Schon and father from West Germany (GP clashed with an important German qualifying meeting) plus a French contingent headed by Pierre Rigot were matched by Britain's best in full strength. A special welcome to Dave Preston who showed that his enforced absence had by no means weakened his driving skills.

The differential brigade were there in strength. Phil Greeno now fully converted to the fibreglass chassis that served him so well at Wombwell — a dozen more were delivered to him at Lilford and he got rid of the lot almost before they were unwrapped. Keith Plested had his Formula car painted in the dark green that will be mandatory for British entries at the Monaco World Cup and did not like the colour at all for visibility against Lilford's muddy grass. However, this did not stop him putting up faster and faster FTD round by round. With the new parts it was very much a matter of establishing new standards and here Keith was in great form throughout the meeting. Neither of the Phils Greeno and Booth seemed quite at their best — perhaps keeping that super car for Monaco?

However, in spite of these reservations Phil Greeno managed to skate the Formula event on Saturday, pursued by Keith Plested, Phil Booth and Ronnie Ton in that order, with the modelling "Andretti" Ron Bates keeping ahead of back marker Dennis Tassaux. Just in passing Ronnie T had a special hush hush silencer that was rumoured to contain all kinds of secrets but nevertheless went home clutching what must be almost the last of Ted Longshaw's current stock of Thorp differentials. Perhaps he has been converted.

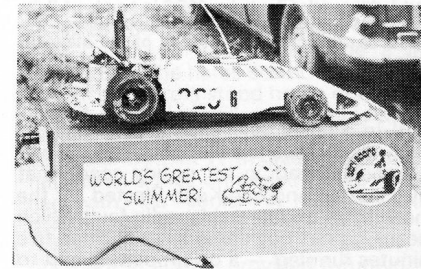

Above: Alfred Schon's appropriately labelled starter box and right The box opened to show simple construction.

Left: Start of the Sports/GT Final with Keith still in the pits.

Below: A general view of the now enlarged circuit to be scene of Euro Championship in August.

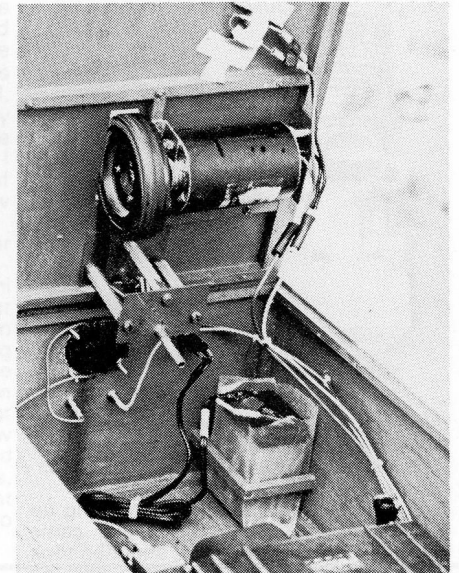

The rumoured tuned pipes did not eventuate, which is not really surprising, since without gearing the narrow rpm band of a tuned pipe cannot be exploited. Once off their ideal rpm they fade away. Ronnie has also been trying them for years but has not made worthwhile progress yet . . . Still the persevering will go in trying.

Contrary to expectations, as political correspondents are wont to say, Sunday proved a glorious day. Speeds continued to mount and it was a real ding-dong to get into the top ten. Only Peter Bervoets and Frank Cronberg were really there.

Dave Preston was getting some good times running a spare car of Phil Booth's. Debbie with her Associated RC200 was also prominent. But it was very much Keith's day with quite fantastic times well ahead of everyone. Dave Rogers, by the way, had a pre-production run example of Ron Irvine's new engine which promises to be a trouble free middle of the road production with many of the desirable characteristics of the OPS plus a slight touch of K and B. Of particular interest is the heatsink head fitted which I understand will also be available for fitting to





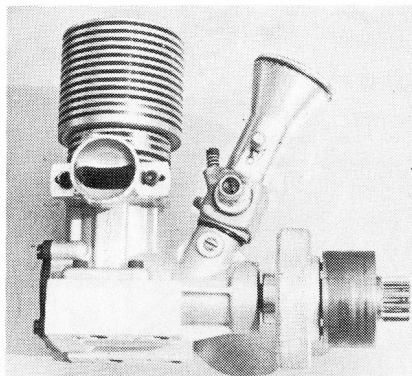

First public outing for Irvine 20RC in hands of Dave Rogers. Air filter flywheel and bellhousing are Dave's but heatsink head is part of the standard engine.

other engines. With a mass production run this should overcome the high cost barrier that individual machining has so far involved.

Some fine new names are cropping up in the handicap finals. Ron Major came through to win on Saturday, and then took third place in the GT Handicap final on Sunday, whilst C. White third on Saturday proceeded to win on Sunday. With adjusted handicaps these two may now let some others in.

Sports GT/Semifinal proved really thrilling with the Prestons father and daughter and Ron Bates fighting it out leaving Cronberg and Rosser the other main contenders out of it. In a last lap cliff-hanger Dave P. led Debbie at the hooter, but Ron Bates whipped past to get over the line second to make the final. Dave sportingly withdrew to let Debbie run in his place . . . "she needs the points" he

Keith Plested's car with his new filter (white for first run but black for production) which contains a specially fine mesh foam (20 micron screen) and is great engine saver.

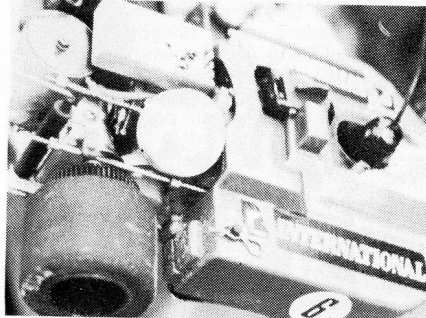

said! In a splendid final she certainly got them. Going like the clappers Phil Greeno scorched ahead in an untidy race, that false started and had Keith Plested off the line with an undetectable radio fault which meant he did not come in until after five minutes running — a disappointing end to splendid meeting for him. Peter Bervoets and Ron Bates, driving over, under, or through, challenged Greeno who kept steadily ahead and drawing away, until right under the rostrum his car suddenly went haywire and that was the end for him (he nevertheless finished fourth for all that) Fault was ultimately traced to a non-stress bearing pinion on the servo that had absolutely no expectation of going, and anyway Phil changes servos every meeting. This left four active runners with a way behind Keith chasing on hopefully. Phil Booth not going quite his usual fast self was mainly behind Bervoets and Debbie who changed places with Ron



One of the Miss Tons talks to Dad : just to show the family team idea is active everywhere. Roony could build up a 6-car race if his family all show interest.

Bates, always dangerous. Debbie, as I have remarked before, was her usual unflurried self, driving an immaculate line a little slower than the hares but no tortoise. This absence of errors stood her in good stead, plus the instant refill service provided by pitman Dad, so that she came over the line a popular winner. With great forethought I had taken a nice unhurried posed shot of her with car earlier in day . . . now gracing our cover.

I should add that Ted Longshaw, for once not in a final, provided a running — no a galloping — commentary for the semi and finals. Organisation was as near perfect as could be. Ninety-six entries on the Sunday, providing a non-stop daylong performance. Radion interference negligible and solved by attendant boffin from Bradford Jeff Lindstrom. Finally, but by no means least, there were the new traffic lights in lieu of the old fashioned starting flag. Red means let go mechanics, green off with you drivers. Slight relocation promised for Euro Meeting to give drivers better sighting.

## BOURNEMOUTH'S FIRST

(continued from page 12)

in touch. The latter running a normal axle with the balance of the car set for the diff. caused some "tail out" driving whilst he mastered the set up. A few laps later Dave Martin dropped out with a broken motor, leaving Keith Plested and Phil Greeno having a battle for the lead, with Steve White still on the same lap. This duel continued lap after lap, enabling Phil Greeno to record a best lap time of 19.8 secs., with neither giving an inch. Then Keith's car came hurtling through the pits, no brakes and slammed into Mark Plested's size 8 boot. Quick investigation revealed that nothing could be done, so he goes back to do battle, just one lap down.

## SATURDAY : FORMULA

Open	Handicap
1. Phil Greeno	1. Ron Major
2. Keith Plested	2. M. Bartlett
3. Phil Booth	3. C. White
4. Ronnie Ton Holland	4. M. Blomfield
5. Ron Bates	5. J. Everett
6. Dennis Tassaux Belgium	6. D. Clifton
7. Ted Longshaw	
8. Paul Padgin	
9. Mark Plested	
10. J. Everett	

## SUNDAY SPORTS/GT

1. Debbie Preston	1. C. White
2. Peter Bervoets Holland	2. J. Turnbull
3. Phil Booth	3. Ron Major
4. Phil Greeno	4. L. Grunow
5. Ron Bates	5. P. Clough
6. Keith Plested	6. J. Harrop
7. Dave Preston	
8. B. Denton	
9. F. Cronberg Holland	
10. Bob Rosser	

Again, we have the same battle with both cars appearing to leap out of the corners with fantastic acceleration. Steve White is however, still on the same lap as Phil Greeno, therefore ahead of Keith Plested after some twenty minutes of racing. Phil Booth had meanwhile rejoined the fray, his only hope being fifth place from the retired Dave Martin.

The remaining minutes saw Steve White lose second place to Keith Plested after his engine cut. Thus: Phil Greeno 1st; Keith Plested 2nd; (2 laps down) Steve White 3rd (4 laps down) Paul Padgin 4th; Phil Booth 5th; Dave Martin 6th.

Miss Bournemouth presented the prizes, which provided the winners with a quite unexpected treat.

P. Errington R. Hutton

## MOVEMENTS AND IMPROVEMENTS . . .

A special welcome this issue to Lightening Models of Blackpool making their bow as suppliers of electric cars and offering a specialist service for 1/12th scale electrics. I am delighted to renew acquaintance with proprietor Mike Booth who played a large part in slot car racing in the early days, flew and designed control line model aircraft, tried for world records on speed go-karts . . . and is now back in the model trade.

C. I. and R. A. Thompson (advertising Digiace with Flight Link) are importing the Italian Mantua car kits which so impressed

at Nuremberg. These will be a medium priced car at under £50 and the top line car at around £100. More next issue.

American car and body specialists Parma International have now moved to their new home 13927 Progress Parkway, North Royalton, Ohio, 44133, U.S.A. Parma also make the popular pistol grip speed controller (used by Debbie Preston amongst others) and quite a lot of the bits and bobs for electric car racing. Move will give them more space for anticipated expansion.





## BOURNEMOUTH'S FIRST

A TOTAL number of seventy-one drivers saw both Saturday and Sunday dawn bright and clear for Bournemouth's first Open Meeting on 15th/16th April. The very first heat got Fred Martin off to a good start with the first of his 12 lap times which were to take him on to the handicap final and a win. Other low handicap with 12 or 13 lap times were Andy Digby, Paul Ekins, Malcolm Barlett, Jim Harrop, Mick Robinson, Ray Lewis and Dave Dunnings.

Dave Martin produced a nice 14 lap in 5.26:4, and looked to be settling into the groove. He was followed home by Steve White and Debbie Preston, each with a low 13. Just to make sure the youngsters were not going to walk away with it, Keith Plested, quite at home on his local track, did 14 laps in 5.17:0 in Heat 5, again closely followed by Phil Greeno and Ted Booker. So after the first round we had just two 14 lap times, but in the next two rounds two more drivers (Phils Booth and Greeno) broke the 14 lap barrier. The fight was now on for the semi-final places. Debbie Preston, Steve White, Ted Longshaw, Ron Bates, Ted Booker and Rob Errington made it, the first two of these going through to the main final, while Gary Culver just missed making the semi.

The Handicap Final gave Fred Martin a comfortable cruise home, but the other places were fought out nearly to the finish with Andy Digby, J. Moon, D. Jones, D. Dunnings and Ted Booker finishing in that order.

In the Open Final Debbie Preston scored a well deserved win, with some fast and refined driving from Phil Greeno, Dave Martin, Steve White, Phil Booth, and Keith Plested in that order.

Prize-giving followed with Mr. Adamson

A well pleased Phil Greeno licks his lips as he takes his cup from Miss Bournemouth. Keith P. looks on benevolently.

from Bournemouth Tourist Office kindly doing the honours. All looked set for another day's racing on the morrow, Bournemouth track's concrete "blips" (christened "Apollo Launching Pads") had caused some consternation and most drivers had a few repairs to do.

On Sunday after some close heat times the Handicap Finalists were: Paul Ekins (fastest qualifier), Lew Gronow, Dave Dunnings, D. Jones, J. Moon and Keith Dumbleton, with John Robinson (rumoured to be connected with a firm called PB) just missing out. First 15 lap time came from Mr. P. B. himself with a 5.15:1. But Phil Greeno sneaked in a faster one with 5.02:7 and then Phil Booth and Dave Martin with 5.13:5 and 5.21, joining them for a sit out. Paul Padgin and Steve White went through from the Semi Final from Dave Rogers, Ted Longshaw, Rob Errington and Paul Ekins.

Handicap Final results were J. Moon winning from D. Jones (2nd) Dave Dunnings (3rd), P. Ekins (4th), Lew Gronow (5th) and Keith Dumbleton (6th).

Drama before the start of the Open Final as Phil Booth struggled against seemingly incurable radio problems, whilst Phil Greeno frantically ripped out his broken differential and fitted a normal axle. Right from the start Phil Booth suffered radio problems, forcing him to the pits for further investigation.

Opening laps had Dave Martin, Keith Plested and Steve White tussling for the lead, with Paul Padgin and Phil Greeno still

(continued on page 11)

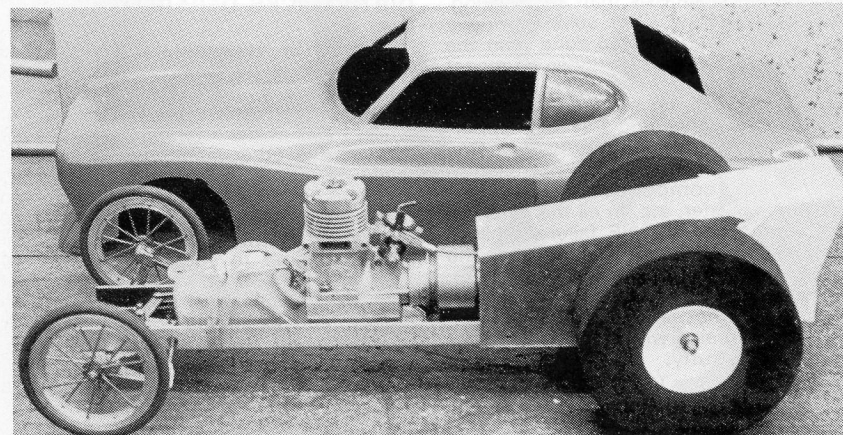

Mr Jackson's less extreme dragster (others were on colourprint and not so good to reproduce) with interesting inline motor location.

## LETTERS...

### SURVIVAL SYNDROME

Dear Mr. L-D,

I can see no reason why you will not produce the next magazine so may I prejudge the issue and congratulate you for having survived the year? May I also thank you for giving two plugs for drag racing, I am one of the two "others" mentioned in Mr. Kightley's letter. I enclose a photo taken at the Santa Pod Easter meeting and one of my car before it received body fixing clips, roll bar, etc. etc.

I feel I must say that I agree with all that Mr. Ashwell wrote, even 1/12th scale (if not intended for all out competition even less excuse!) and I have been generally put off circuit car competition by what seems to me to be a lack of interest in scale. I do still build model circuit cars, but would not want to race them in competition, it would be a waste of time. I am lacking in driving skill and am happy to merely see the models move under their own power. My pet hate of bloated bodies led me back to dragsters and to this end I made the model mentioned previously, to see what it would be like to move to the other extreme.

The inner body is 2 1/4 in. wide (which I justify by saying that I am thin and would just fit inside a 16in. rollcage) and, according to me, everything is in its proper place for this type of car. i.e. from the front:— Axle, fuel tank, motor, flywheel, clutch, servos (legs?) rear axle, RX and DEACs (driver's body?) So, if you want a slim car, it will all fit in and there is nothing

to stop a scale veteran model from being made. I willingly admit that parts are not very easy to come by but there are helicopters gearboxes and also the Micart and Graupner models. Mr. Ashwell did not blame the modeller without workshop facilities. I would be glad to hear your views on "scale" and perhaps you can help with following questions.

Is the Graupner model using a 45 deg. bevel drive (implies 1:1 ratio) only or is there gear reduction elsewhere?

Does anybody import Micart parts?

Does anybody import the Dutch kit? I am especially interested in the hubs which might enable me to attempt my favourite sports car (Chaparral).

What was automatic about Mr. Thorp's car? (page 20 Issue 5)? Variable gear ratios would help dragsters a lot let alone the diff.

I don't remember Delta's worm-drive but I can remember (1971) a model with double wishbone suspension all round, in line mid engine and torque converter, the name "Dynamic" rings a bell . . . and I wonder where they have gone . . .

Yours sincerely,

S. G. L. Jackson

Bristol

### SILVER SOLDERING IS SAFE!

Dear Sir,

I would like to refute Pete Crawley's statement in your last issue that silver solder is not very strong for stock cars. If properly applied silver solder will give the



novice a better chassis than arc welding. This is due to the silver solder giving a much larger heat affected zone than the weld in **practice** and is tougher as impact tests have proven.

I can also back up the theory with the practice. My father and I (Team Spiller) run two cars prepared in this manner. One car is over four years old and has been to many hard competitions, including Holland, Leicester, etc. In all this time we have suffered **NOT ONE** failure, whilst I have seen two arc weld failures on the same day on different cars (Sandown '76).

Keep up the good work so far, but please, could not someone tidy up contributors' diagrams with at least a ruler, it really looks scruffy.

Yours faithfully,  
Ian Spiller

M.I.M. Tech.  
Chertsey.

#### GOOD BEGINNINGS

Dear Sir,

I have just completed my first kit, Mardave and Veco, as I believe these are good value for the beginners' choice. My first outing with the car was however very enlightening to the fact that it takes quite a bit of skill to control it at speed. Still, I hope after practice it will come a lot easier. I have found that the needle valve on the carburettor takes a bit of getting used to as I still cannot get full revs without the engine cutting out (any advice would be most welcome).

As far as the mag goes, I agree with J. Lee — if possible a monthly one. Also what about a calendar in the New Year with photos of various models, and maybe a RCMC diary with technical data, tips, and calendar of events.

Yours faithfully,  
B. J. Colman

Bedford

Dear Sir,

I am a committee member of the car section of Boston Modelling Club. At present we meet on Sundays at a car park in town but we are looking for somewhere more permanent.

Most of our members have Mardave kits with a mixutre of Sports/GT and Formula and Stocks, about a dozen in all. I have a McLaren and have found it to be a very good and exciting car.

I think the magazine is very good but I would like to see colour pictures and more reports on smaller club meetings like ours.

Yours sincerely,  
M. Green

Boston

#### DIRTY TRICKS DEPARTMENT

Dear Sir,

I would be very grateful if you could inform if it is possible to obtain copies numbers 1, 2, 3 and 4 as the copies that I had have been stolen from out of my car whilst I was at the International Circuit at Tibshelf the other Saturday. I most certainly do not consider any of the club members or any other club member to have taken the magazines, but more so the spectators as these are the people who have the time to roam about, and of course not so much notice is taken of them whilst racing is in progress. I am hoping you can help with these four issues . . .

Yours faithfully,  
Keith M. Skidmore  
239 Alfreton Rd.,  
Blackwell,  
Derbys. DE55 5JN.

(Ed: We have supplied issues 1, 2 and 4 but No. 3 is already O/P. If thief reads this and has now enjoyed his copy perhaps he will return same to owner.)

#### GETTING THE RECORD STRAIGHT

Dear Ed Dickie,

Thank you for a very enjoyable mag. . . .

Just one point to put the records straight. In issue 2 Stewart Busby wrote a piece about the Newbridge Club. A good report in itself but for one mistake. In the bit about presentation of trophies the last one was by Wyvern Tubes. This trophy was presented for a special class in 1976 for HOT ROD cars. I won it myself making me world hot rod champion r/c (I believe Barry Lea was fullsize champion that year). This trophy was then presented back to the Mardave Owners' Club by myself to be raced for in a Saloon class in 1977.

On another matter I had heard a lot of reports about Tibshelf that the banking was far too steep and drivers found it difficult to keep their cars on the track but to my enjoyment I found this bend very good; the other bend farthest away to the right gave me far more trouble, as you cannot see it very well, and this might surely have been banked a bit. Otherwise the track is very good. It is a shame they withdrew their request for the Nats as this could have been a very good venue.

What about a selling page where people could advertise any equipment they no longer required, or someone might need something that is no longer on the market?

Yours faithfully,  
Keith Payne.  
Burbage, Nr. Hinckley.

# 308 PIT STOP

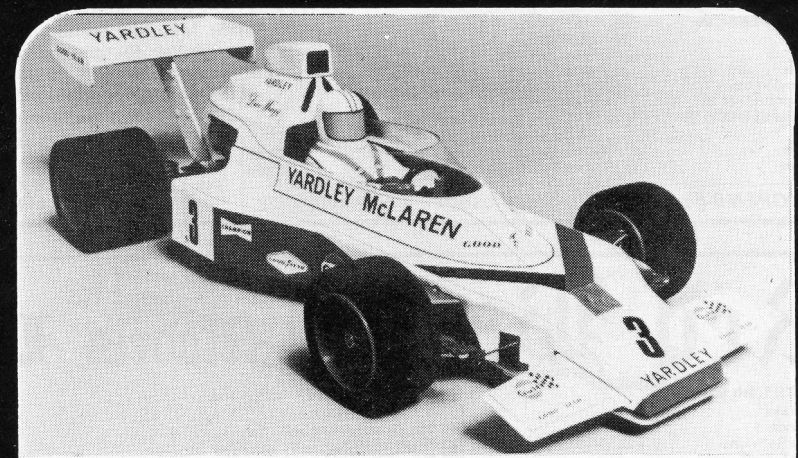

**MARDAVE kits:** 1/12th Scale McLaren M23; Lola T294; Capri RS Saloon; Firenza sal; Stock car all complete with clutch **£23.75**. New from Mardave — Electric Car, complete **£38.95**. MRP from **£59.95**  
**P.B. PRODUCTS:** Expert Junior **£35.67**; Expert standard **£45.05**; Expert Int'l **£75.00**. Expert Competition **£56.21**. Racing dble **£29.30**.  
Kejon Stock Car **£28.50**. Electric kits **£44.95**.  
**SANWA** Porsche electric drive complete with R/C function **£59.95**.  
**TAMIYA** 1/12th scale Porsche-Turbo. Electric drive **£34.99**.  
**ENGINES:** ST X21 with ht. sink hd. **£44.12**. OPS 3.5ccs **£39.95**. K & B 3.5ccs car spec'1 **£47.50**. Veco 19 car spec'1 **£22.45**.

ALL MAKES OF R/C EQUIPMENT STOCKED AND FULL RANGE OF SPARES  
We accept ACCESS, AMERICAN EXPRESS, BARCLAYCARD, BANK AMERICARD,  
HOBBYCARD, QUADBONDS

WORLD-WIDE MAIL ORDER

## HENRY J. NICHOLLS & SON LTD.

The World's Greatest Model Shop for the Enthusiast!

308 HOLLOWAY ROAD, LONDON N7 6NP. Telephone: 01-607 4272.

(2 mins from Holloway Rd. Station on the Piccadilly line)





# MODEL CRAFT

5 CROSS STREET, BLABY, LEICESTER.

Telephone Leicester 771397

## MARDAVE R/C CARS

McLaren M23 Kit	£23.75
Hesketh F1 Kit	£23.75
Capri RS Saloon Kit	£23.75
Firenza Saloon Kit	£23.75
Stock Car Kit	£23.75

## MARDAVE SPARES — Mk 4 RACING CAR

Rear axle bracket	70p
Brake unit	33p
<b>SERVO SAVER</b>	
Steering bellcrank complete	66p
<b>FRONT SUSPENSION</b>	
Complete	£2.50
King pins	10p ea.
Coil springs	10p ea.
Axle with nylon block	20p ea.
Steering arms, LH or RH	20p ea.
<b>FLYWHEEL/CLUTCH UNIT</b>	
Complete	£3.75
Clutch shoe	25p ea.
Tubular pins	03p ea.

13t hardened steel gear	70p ea.
Bush for gear	25p ea.
Cork lining	06p ea.
Clutch drum complete with gear and cork lining	£1.60
Clutch springs	08p ea.
<b>REAR AXLE</b>	
Bearing	55p ea.
Bearing lock nut	20p ea.
¼" Nyloc nut	09p ea.
06p ea.	

<b>WHEELS</b>	
Front	35p ea.
Rear (with integral drive gear)	70p ea.
<b>TYRES</b>	
Front, standard rubber	60p ea.
Front, hard rubber	70p ea.
Rear, standard rubber	£1.05 ea.

<b>RADIO CRATE</b>	
Complete	£1.30
<b>FUEL TANK</b>	
Driver figure	60p ea.
26p ea.	
<b>ACCESSORIES</b>	
Engine silencer	£2.35
Engine heat sink (for extra cooling)	£1.25
Transfers (Giant size sheet, 84 sponsors decals + 35 numbers)	£1.25
Starter sheet (4" dia. hard rubber, for electric starter)	£1.35
Air filter for Perry Carb	80p

## STOCK CAR SPARES

Silencer	£2.35
<b>FRONT SUSPENSION Complete</b>	£2.50
<b>REAR SUSPENSION</b>	
Radius arm	38p ea.
Radius arm spring	15p ea.
Radius arm attachment nut	12p ea.
Rear axle	40p ea.
40 Tooth drive pulley with tube pin	70p ea.
Drive belt	55p ea.
<b>FLYWHEEL/CLUTCH UNIT</b>	
Complete	£3.75
Clutch drum with 8t pulley, cork lining and retaining washer	80p

**SPECIAL:** lightweight flywheels for Mardave standard clutches, essential for the serious contender **£2.40**. P.B. Style silencers complete with manifold, at only **£6.95** (highly recommended).

## BARCLAYCARD & ACCESS WELCOME

POSTAGE on MARDAVE KITS FREE  
Decals 10p Parts 50p

SHOP OPEN 9-6 p.m. Mon. to Sat. Closed all day Wednesday

# Red Baron Models Ltd.

## CAR KITS 1/8th SCALE

International	£75
P.B. Standard	£45.04
Mardave Race Car	£23.75
Mardave Saloon	£23.75
Mardave Stock	£23.75
Delta from USA	£75.00
S.G. Competition	£60.00
S.G. Futura	£72.50

## SPECIAL ITEMS

Perry Pumper 61 Carbs	£7.95
Dynamic Slide Valve	£16.95
O.P.S. 61 Slide Valve	£11.95
Super Tigre Carbs	£4.50
Robart Pumps	£10.66
Mardave Filters	85p
P.B. Air Filters	£1.65
Associated Filters	£2.60
Big Shot Fuel Bulb	£3.25
Associated Flip Tops	£3.55

## SPEED CONTROLLERS

Smoothtronic	£26.83
Viking	£22.75

## CAR KITS 1/12th SCALE

Mardave 6-cell	£37.50
Mardave 4-cell	£33.50
Lectricar	£44.87
Bo-Link	£58.00
M.R.P.	£59.95

## R/C ENGINES

Super Tigre X21	£44.57
O.P.S. Car	£42.95
K. & B. 21	£47.50
O.P.S. Std.	£35.95
O.P.S. R/C	£38.95
Veco 19 Car	£24.95

Heatsink Heads	£8.64
Rat File	55p
Pressure Cap	40p
Parma Trigger Kit	£3.10
Delta Out/Put Arms	£1.00
Delta Over-ride	£2.50

**AMPS DIFFERENTIAL**  
for PB £42.00

Full range of tyres 1/12 and 1/8. Body shells car spares. Engine spares and Radios, etc.

Phone your credit card number for quick mail order

**497 HERTFORD ROAD, ENFIELD, MIDDLESEX**

Late night Fri. 7 pm. Easy parking  
Tel. 01-804 7452

# Irvine 20RC Car

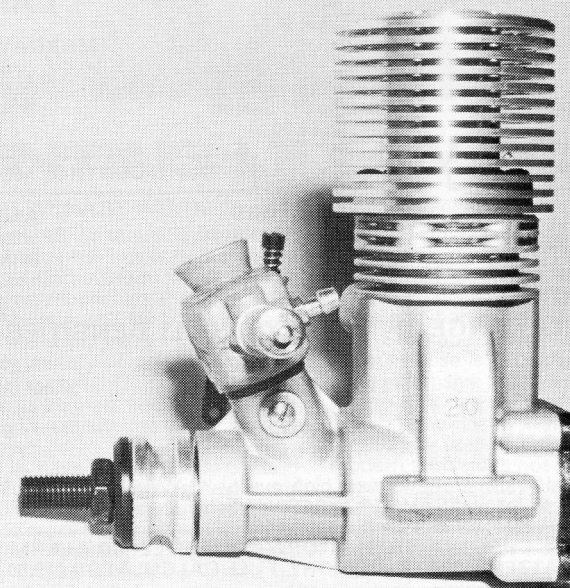

The new Irvine 20 R/C Car is an engine designed for those who appreciate and use better components. The 20 R/C Car, as you would expect, has Schnuerle porting and is engineered from a large number of high quality investment castings. The conrod is a substantial forging from high duty alloy and incorporates a phosphor bronze big-end bush. The crankshaft is machined from high quality steel and is supported in precision ballraces. The 'superior quality' philosophy extends to an investment casting cylinder liner of hardened steel; the piston is investment cast in low-expansion silicon-alloy and is fitted with a low friction Dykes ring. Everything about the Irvine 20 R/C Car is engineered to excess of normal standards. Except the price **£35.95**



# IRVINE

Irvine Engines,  
Unit 8, Alston Works, Alston Road,  
High Barnet, Herts. Tel: 01-440 0923



Mail Order Only

C.W.O. as priced  
No Postage

No. 1 REGENT ROAD,  
BLACKPOOL LANCAS

**LIGHTNING**

**MODELS** THE 1/12th SCALE  
**ELECTRIC**  
**CAR CENTRE**

Monday to Friday  
11.00 — 2.30

Phone Blackpool 25912  
Ask for Mike

M.R.P. 6 — CELL BUILT  
Less radio  
£59.95  
Complete with radio  
£167.00

**CAR KITS**  
**LECTRICAR 6 — CELL KITS**  
Porsche 936 Sports  
Escort R.S. Saloon  
Porsche 911 Saloon  
£44.50

**MARDAVE 6 — CELL KITS**  
B.R.M. F.1  
£37.50  
B.R.M. 4 — cell  
£33.50

1/12 TRANSFER SHEET 95p

Bodies

RADIO CONTROL MODEL CARS 50p

M.R.P. Lexan  
Range of 10  
Clear £6.90  
Painted £9.40  
Rear Aerofoil £1.87

Lectricar ABS  
Porsche 936 Kit  
Escort RS Kit  
Porsche 911 Kit  
£3.25

Mardave ABS  
Porsche Body Only  
BRM Body Only  
Shadow Body Only  
£1.95

**FULL RANGE OF 1/12th TYRES ALL DENSITIES**

**MODELRAFT ABS**  
Mardave to Tyrrell 6  
Conversion Kit £3.95  
Turned A'looy Wheels  
Drivers ABS to follow

**NEW SAVAGE**  
Extra Detailed ABS  
Escort RS £2.50  
B.M.W. £2.50  
Tyrrell 6 £2.50

**NEW SAVAGE**  
Clear Detailed Macralon  
Escort RS £5.50  
BMW £5.50  
Tyrrell 6 £5.50

Note: We have arranged to distribute the new high quality "SAVAGE" range of bodies 1/12 Harrow, J.P.S. LOTUS, Tyrrell 4 to follow "SAVAGE TYRES" available soon (Trade enquiries cordially invited)

**SPECIAL: 5 x 2½ins. CHRONOGRAPH, STOPWATCH, BLEEPER ALARM, LAP COUNTER, BATTERY TIMER, MEMORY, FULL CALCULATOR £19.50**

M.R.P. Lectricar Mardave full and complete range of spares in stock NOW! Every nut, bolt washer and component

Car Radio Combos  
Just buy radio, batteries, build  
MacGregor/Mardave 6-cell £95.50  
MacGregor/Lectricar 6-cell £102.50  
MacGregor/M.R.P. £117.50

MacGregor Radio Dry Cell Outfit 2-channel £61.00

EXTRA Group Demonstrations in Blackpool or Northwest Lancashire area gladly arranged

STOP PRESS: CLOSED  
AUGUST 4th-14th. You can find us at Woodvale Scale Internationals

## I & D ELECTRONIC CO'S "SMOOTH TRONIC"

Electric Car Speed Controller with Proportional Throttle and Proportional Dynamic Braking

**VERY WIDE RANGE OF ENGINE SPEEDS** — for precise control over all manoeuvres (e.g., smooth handling through corners). **FULLY PROPORTIONAL DYNAMIC BRAKING** — giving a smooth transition from full power, down through "neutral" to maximum braking. **PLUGS DIRECTLY INTO RECEIVER** (positive 1 m/s-2 m/s) for elimination of servo, push rods, complicated wiring, unreliable switches and hot resistors. **PERSONALISING ADJUSTMENT** — The position of the TX stick at full throttle, neutral and braking is pre-set by 2 small adjustments. **SMALL SIZE** — (1.6 x 2.4 x 0.9in) — for quick and easy installation. **LIGHT-WEIGHT** (2 oz.) — for maximum acceleration. **HIGH POWER CAPACITY** — for 7.2 volts, 12 amps (25 amps peak). **ONLY 0.2 VOLT DROP AT FULL POWER** — ensuring no reduction in performance in acceleration and top speed. **LOW POWER CONSUMPTION** — for very cool running, and more power available at the wheels towards the end of the race. Send cheque or postal order to:

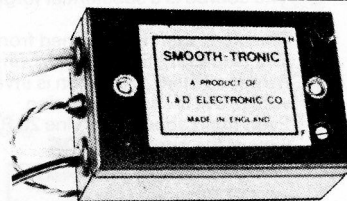

**PRICE: £26.83** (Inc. VAT + p/p)

(overseas: £24.35, inclusive)

(Trade enquiries welcomed)

**I & D ELECTRONIC CO. 46 Church Road, Barnes, London SW13, England Tel. 01-741 0333**

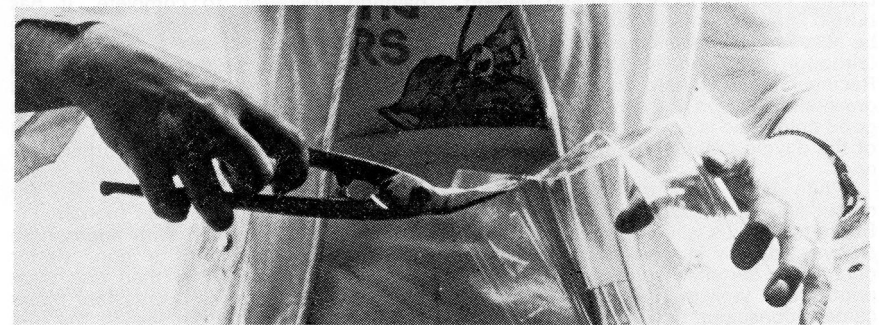

## PAINTING LEXAN BODIES

### PRELIMINARY WORK

UNTIL recently a Lexan bodyshell was very much of a luxury, but with the recent introduction of home produced shells the price has come much closer to the ABS type body. Range is still fairly limited, and recourse to the wider range of American imports is necessary if an exotic body shape is demanded. There is also the range of ready painted bodies, again for money plus, to satisfy the ultra lazy or hamfisted driver.

It is usual to have both Sports/GT and Formula bodies to use on the same chassis with a minimum of alteration, perhaps, hopefully little more than a different pair of bumpers and retaining posts. Some compatibility of size should be looked for in making a choice.

Bodies all come with the sheet edges still sticking out all round. These must be cut away. With Butrate bodies the choice is between cutting with scissors or with a hot iron (very smelly). Lexan is tougher and the ideal cutting implement is a good pair of tin snips. Look your body over and check that there are clear indentations where wheel arches come and where the body ends. Some may be very vague so mark them in on the outside of the shell in a chinagraph pencil line (it can be wiped away afterwards if any remains). Finish the edges with sandpaper to get good and smooth. It pays to make up also a small round sander out of, say, an old boot-polish tin with the bolt through it with a strip of glass paper stuck round the edges. This is a round way of finishing wheel arches when mounted in an electric drill.

Just to be very obvious: the paint goes on the *inside* of the shell! To get good adhesion rough up the surface with a little steel wool, taking care *not* to touch any

Some good tin snips are the ideal tool for trimming a Lexan bodyshell.

windscreen openings or the like where simulated glass finish is required. These areas had better be masked off early on. The Sellotape brown parcel tape of a Melanin base is good for this though it is quite expensive to buy as a roll. Failing this I have a fondness for the old fashioned brown paper sticky tape, which should be thoroughly wetted before putting on. The modern stuff does not seem to stick like it used to and it may be necessary to add some flour paste to get a real good stick. It washes off in warm water afterwards. Always check that edges of any masking such as this is as firmly fixed as possible. If you are masking off large areas tape edges only then fill in the bigger areas with newspaper or similar — saves tape.

While the shell is still clear slip over your car and see where the cut-outs will have to come. Use the faithful Chinagraph pencil to mark them in. Cut out with a drill hole first, then slip a fretsaw blade through and cut round. It can be done with a knife blade but is more liable to slip. Wrap a piece of sandpaper round a pencil to finish off openings for things like fuel filler.

### THE PAINTING

Well what colours are you going to use and why? Don't be obvious! One heat in British G.P. attracted six cars all in red basic with white stripes — a timekeeper's nightmare, let alone a driver's! Colouring, apart from looking pretty, is mainly to enable the driver to pick out his car at a distance, his pit men to snatch it in for refuelling, and generally for supporters to be encouraging the right car. Another and more profitable use is for a sponsor's



colours and name to be imprinted thereon, but do keep in mind the primary need is to be able to see it. Dark green for example (although traditionally the old British Racing Green) is hard to see against a grass shoulder on the far side. Yellow is good colour, so is orange, and even some of the dayglo colours if you can get good ones.

White is a wonderful standby base colour and continues to be very popular. Butyrate cars usually come in this colour anyway so early laziness is impressed on one. Blue, certainly light blue, does not photograph well in black and white, so camera conscious drivers should beware. Dark blue is splendid, and also that middle blue sometimes called Rolls Royce Blue, but any pattern should be enlivened by stripes of one sort or another. Fashion seems to be to run them lengthwise on the car. I prefer transverse stripes, good and broad at the nose end of the car. Easy to see and quick to distinguish which way the thing is pointing.

When all else fails look at **Motor Sport** colour section for ideas — but remember you have got to do the work so make it fairly simple. True scale finishes — John Player Lotus in black and silver for example — look beautiful when fresh, but oh, the grief when it rolls over and over!

Make a sketch of your proposed scheme in colour (colour bios) and then cut out the masking in bits. This can be done on a sheet of glass — failing a better piece lay it out on a good big window, which is quite practical if self adhesive tape is used. Otherwise on a glass coffee table if non sticky masking is use. Shapes can be cut with a pointed modelling knife, using a coin for curved parts, or a cup, or a glass bottom for guiding with bigger pieces.

### THE PAINT

The paint and how to apply it is next. You can use the inevitable spray can from any motor accessory shop — I am just as guilty here as anyone — it is so simple quick and clear. It may chip off and will require fuel proofing but it meets an immediate need. I also continue to use my old Humbrol Jet-Mix spray gun with refills, which may or may not always be on the market. If you are not yet committed it would pay to get a middle priced outfit such as the Badger air brush which will last for a long time and also serve to touch up the family car between times. Or you can use brush — coachbuilders did for hundreds of years. I have some cans of the special Lexan paint that Ted Longshaw sells. This is fuel proof so only requires one

painting operation to complete. It has been specially mixed for the job with the necessary amount of plasticiser and pigmentations for solid colours. Only snag at the moment is the somewhat limited range of colours available. Also, imported from U.S.A., is the **Perfect Paint** offered by Mick Charles Models, another fuel proof paint, again without any very bright colours since it is mainly intended for model aircraft use and scale models.

Either can be thinned with appropriate thinners and used with a gun. Better several light coats rather than one thick coat. Give the job a full twenty-four hours to dry thoroughly before testing the fuel proof quality, but peel off adhesive tape within half an hour: sticky tape leave on and wash off later.

### GOOD ADVICE ON THE PAINT CAN

"Almost all drying problems are caused by: (1) Using the wrong thinner, (2) applying when too cold or too humid (apply paint at temperatures above 70 deg.) (3) resins under the paint not dry (allow 72 hours for any epoxy filler or other potential soluble to dry).

"If paint comes off when masking tape is removed it is because (1) the wrong thinner was used, (2) the surface was not properly sanded, (3) the paint was not dry." Use good quality plastic tape.

## SHOPPING AROUND

recently for glowplug use. This has flexible lexan chassis, wheels, tyres, etc. and sells at £22.98. Just the job for the semi-scratch builder. They still have SG Expert and Professional kits in stock. Model Rectifier Co (UK) are now importing the new SG Futura of which so much is expected. Jack Williams, ex-Humbrol executive, is heading MRC (UK) and tells me he has a good stock of these kits and has only been awaiting adequate spares back-up to distribute them. In fact the spares ratio to kits came as something of a surprise to him when the first shop tackled took the lot! However, by now loads more should have poured into the warehouse.

Watch out for a whole new range of practical accessories from the Greeno stable. Phil is arranging to market some of his own special goodies including his very successful glassfibre chassis, all cut out and ready to fit at £8 (or plain sheet — you do the work £5), first run of which was eagerly grabbed at Lilford Park by home and away drivers. Another nice one is his disc brake fitting which allows adjustment of brake tension without involving any change in throttle setting.

# SHOPPING AROUND

THIS is being written before the Nats and the World Cup so that any results there have not been taken into account when I say that the big buy just now must surely be a differential. This season the differential boys have been clocking up success after success on all kinds of tracks to a degree that should have made John Thorp's heart and pocketbook glow . . . if there hadn't also been a number of other people coming in on a good thing too. Just to add spice to the mixture Ronnie Ton, over for the British GP, took a Thorp home with him from Ted and spent the next few days installing it to win both legs of the Dutch GP the following Sunday. "Yes, but he might have won without it" . . . of course, but he didn't. First of the new crop of diffs to share the pickings with John T. is the AMPS version as run and won by Phil Greeno. This is a real package deal including rear axle mounting — plummer blocks that is — and disc all designed to go straight on to a PB International . . . price £42.95. Phil Greeno must be congratulated on interesting the AMPS people, and their design department patted on the back for efficient research. After every race they took Phil's comments to heart and re-designed it until it filled all the driver's needs. It still isn't unbreakable — nothing is — but it is just about the winningest gadget on offer today. Meanwhile the good old well-tryed John Thorp has still a lot of mileage in it and will be in constant demand. Coming up fast is the next contender from the PB stable which will have spur gears not bevels. This makes for a smaller gearbox, less wear and more positive drive, as well as being slightly simpler to make . . . so price should be competitive. Swiss Brem will, we suppose, still be available also though I have never seen one not used with the Brem belt drive . . . nor had the Thorp until recently.

The new PB Slide Carb should also be in production any moment now. Keith was reluctant to go into a large run until after Monaco, but within a week or two now results of the pilot run should be available, and he will know more of the answers . . . the sooner the better, there is quite a dearth of slides.

Next product news must be the arrival of a **British**, yes British r/c car engine in the shape of the Irvine 20. Prototype appeared in our Issue No. 2. Reality is not really very like it with an Irvine carb and a special built-on heatsink head. As men-

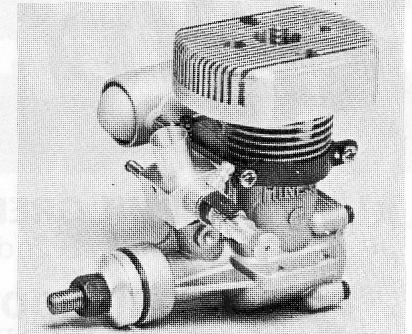

Hines 20BB ST — an interesting newcomer from Japan to be marketed by our advertiser Hobby World.

tioned elsewhere Dave Rogers has been trying it out with success and reports good middle of the road performance . . . the boys will soon get to breathing on it and we shall see its potentialities. Heads will be available also to fit other engines which should give us a pleasant feeling in the price tag. Available, they say, by the time this comes out.

Another **British** item to rejoice over: the Talisman Series and Midget Digit Series radio gear from World Engines at Watford. Mick Wilshire has been sitting on his modest treasure without saying a word — or not very loudly — until now. For £56 odd you can get the lot: Tx, Rx, two servos, harness. So, modest-pocketed people can get on the track with an electric outfit really running for less than £100 all up (with Mardave 1/12 or a few pennies over with Lectricar — not much more with MRP). It is a neat little outfit — dry of course for that money but with an all Nicad version available as well. We know at least one very staisfied lady user in the electric car field. For those thinking in ever smaller terms of 1/16th and even 1/20th scale Talisman is a good buy being conveniently small. For more robust use, club racing in 1/8th etc. it should also be acceptable — after all Mick will always make you up almost armour plated servos if you are very crash prone!

World Engines continue to handle the Super Tigre engines regarded by so many as the most promising, even though, as yet, not so professionally breathed upon as the Veco and K & B. They are also handling a bare chassis version of the Little Big Car 1/12 scale job we had

(continued opposite page)





# INTERNATIONAL

**1st**  
**3rd**  
**4th**  
**6th**  
**1st**

**PHIL GREENO**  
& 2nd FASTEST QUALIFIER 56 laps

**PHIL BOOTH**  
FASTEST QUALIFER

**KEITH PLESTED**

**GUERRINO STANZANI**  
FASTEST ITALIAN

2nd SUBFINAL  
**DAVE MARTIN**

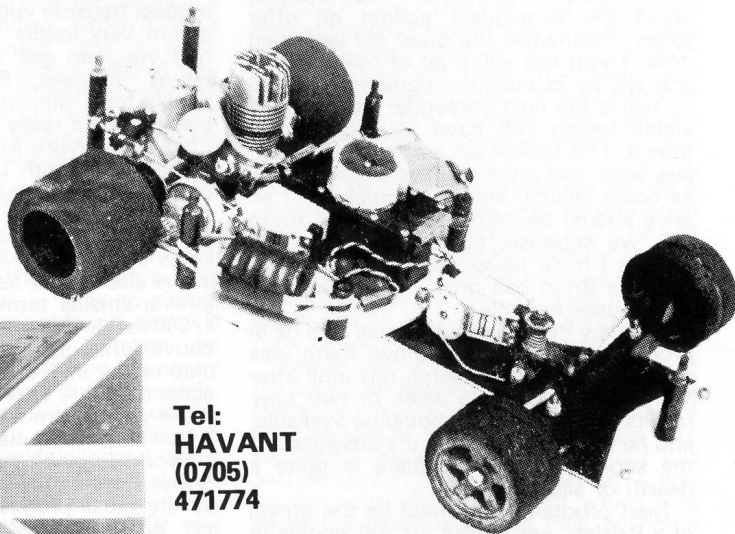

Tel:  
**HAVANT**  
(0705)  
471774

**PB PRODUCTS DOWNLEY RD**  
**HAVANT HANTS**



AT

# MONACO WORLD CUP

FORMULA 1

## THE BRITISH DRIVERS

*Left to right: Debbie Preston, Ted Longshaw, Phil Greeno, Dave Martin, Phil Booth and Keith Plested.*



PHOTOWORLD PICTURE



# INTERNATIONAL





## "BRITISH NATS"...

By JOHN PARKER

THE 1978 British National Championships took place on a very hot and sunny Spring Bank Holiday weekend at the Wombwell Sporting Association's circuit near Barnsley, South Yorkshire, with sponsorship by Hobbycard. Competitors struggled around the winding Wombwell track in the very hot conditions, trying to set up the cars and the engines and avoid getting too sunburnt.

Since the April meeting the circuit had been rolled and lined with the help of the local council and it looked as if some very fast times were going to be set over the three-day meeting. Races for Formula 1 cars were held on Saturday, Saloon Cars on Sunday, with the climax of the Sports/GT cars on Monday.

The circuit is very demanding on drivers and requires a good deal of practice just to drive around without coming off or hitting anything. The hardest working people on Saturday morning during practice were the marshals, who were busy putting cars back on to the track. When driving the cars anti-clockwise, as in Formula, the circuit has two very tricky bends which get tighter as you go around them, the looping left-hander in the middle of the track and the left hander on to the main straight.

A lot of thought had obviously gone into the organisation of the races. There were

two PA systems, one for the pits and surrounding areas and one for the drivers on the rostrum. Marshalling in the heat after driving was enforced by checking required drivers against numbered positions around the circuit. Failure to marshal meant that offender's FTD was deleted!

After the drivers 'briefing' by Paul Pagdin, the heats started and laps numbers began to go up, with drivers clocking 8, 9, 10 and even 11 laps during the five minutes run. There were a lot of claims of interference which slowed down the heats, but all the claims were patiently checked out by Jeff Lindstrom, who was busy on the PA and frequency monitor. Later in the day it was noticed that some peoples' transmitters were giving signals off their own colour, but only when standing on the rostrum, presumably caused by the metal framework put up for the roof. The ever-helpful race director Paul Pagdin asked for volunteers to cut off the offending steelwork and racing got started again. How much of the "interference" was caused by radio signals and how much by excited drivers or poor radios is open to a lot of argument but the officials still did everything they could to help out.

General impression of Wombwell, taken where the old and new tracks join. Right: Winner groups, from top Formula, Saloon and Sports/GT all clutching their awards.







The backroom benefactors: Jeff Lindstrom — PA and commentator; with timekeepers Muriel Russell and Eric White who manned the control tent for three long days.

Gary Culver the new Saloon Car Champion.

At least two engines failed in the heats (literally) on Saturday. John Russell had the cage on the rear bearing of his K & B break and Robin Ellis changed his OPS for his K & B after a suspected front bearing seizure. A lot of rubber and oil was laid on the track during heats and the finals were set to be very good races.

The semi-final saw a ding-dong battle between Paul Pagdin and Ken Wright for the first two places. Paul led, but cut out, and then rejoined the race, and on the last lap nerfed Ken out of the way to win. It didn't matter though as both went through to the final.

Both Handicap Finals were close exciting races and in the 0- 15% final all the cars finished on the same lap. Ray Watson put his car amongst the spectators at the end of the straight a few times which soon moved people back.



The Open Final to decide the British National Formula Chjampion was packed with excitement as well. Straight from the start Paul Pagdin shot into the lead and built himself a comfortable cushion against the rest as the next four places changed every lap. Steve White has engine problems and Gary Culver cut after 15 minutes after pulling into third place, but there were still three cars on lap 36 with Bob Denton second and Ken Wright third. Paul was three laps in front and settled down to drive to the end when he pulled into the pits. Feverish work by mechanics failed to detect the stiff steering and Paul's championship hopes were gone! The battle was now between Bob and Ken with about one second separating them. Bob crashed and Ken Wright was through to become Formula Champion.

Saloon racing started on Sunday with cars running in a clockwise direction. There were eleven heats to run, as in Formula, but some different faces as new arrivals turned up and some dropped out to save machinery for Monday.

Most of the cars were PB Internationals, or started life as PBs. There were half a dozen or so AMPS differentials on cars and a couple of scratch builds. There were some people using plastic chassis, most were commercial, but a couple of people had laid up their own using glass and carbon fibre reinforcement. Most drivers were using K & B engines, with some Super Tigres and a few OPS's. In the hot weather it was possible to use the torque of the K & B as the traction was very good.

With Saloon bodies fitted drivers mainly experienced excessive front end grip and went to the hardest tyres they could. The enclosing bodies caused overheating

problems during the races.

The start procedure was changed for Sunday's Saloon heats with rolling starts down the straight. This enabled the cars to be in some sort of order around the first bend, but there was still usually a melee in this area. There was generally a better selection of bodies on display for this event with Porsches, Corvettes, BMWs, Capris and others to be seen. Again, eleven laps in the heats was pretty good going.

The semi-final saw a battle between Robin Ellis, Bob Denton, Ken Wright and Ted Booker, with Ken and Robin going through to the final. The Handicap Finals were good scraps, Fred Livesey coming out top in the 20% final with his scratch built car, engine and diff!

The Open Final saw Paul Padgin off into the lead again, as in Saturday's final, followed by Robin Ellis and Ken Wright. Robin later dropped back as Steve White stormed through into second place and diced wheel to wheel with his Hobbycard team mate after re-fuelling together. While this was happening Gary Culver was driving up through the field, after radio problems early in the race, and took second place just after the half way mark. He slowly reeled in Paul Padgin and took the lead when they refuelled together, Paul's engine sounding very sick as he opened the throttle to get back on the track. Paul desperately tried to catch Gary but could make no impression on the ice cool leader, and Gary became National Saloon Car Champion.

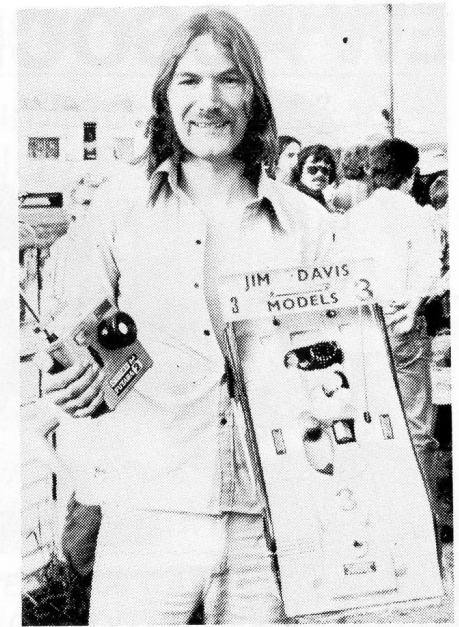

Ken Wright a Double Champion with both Formula and Sports/GT to his credit. Note his attachment to the wheel-type Futaba.

Another view of the track, showing rostrum with its Hobbycard banner, and the caravan village in the background.

(Continued on page 36).

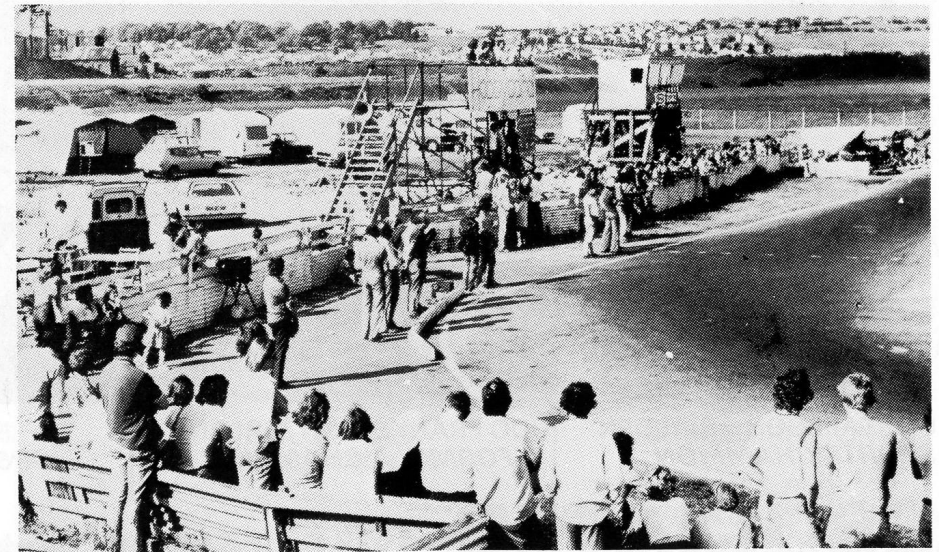



# NEW ASSOCIATED RC 200 KIT

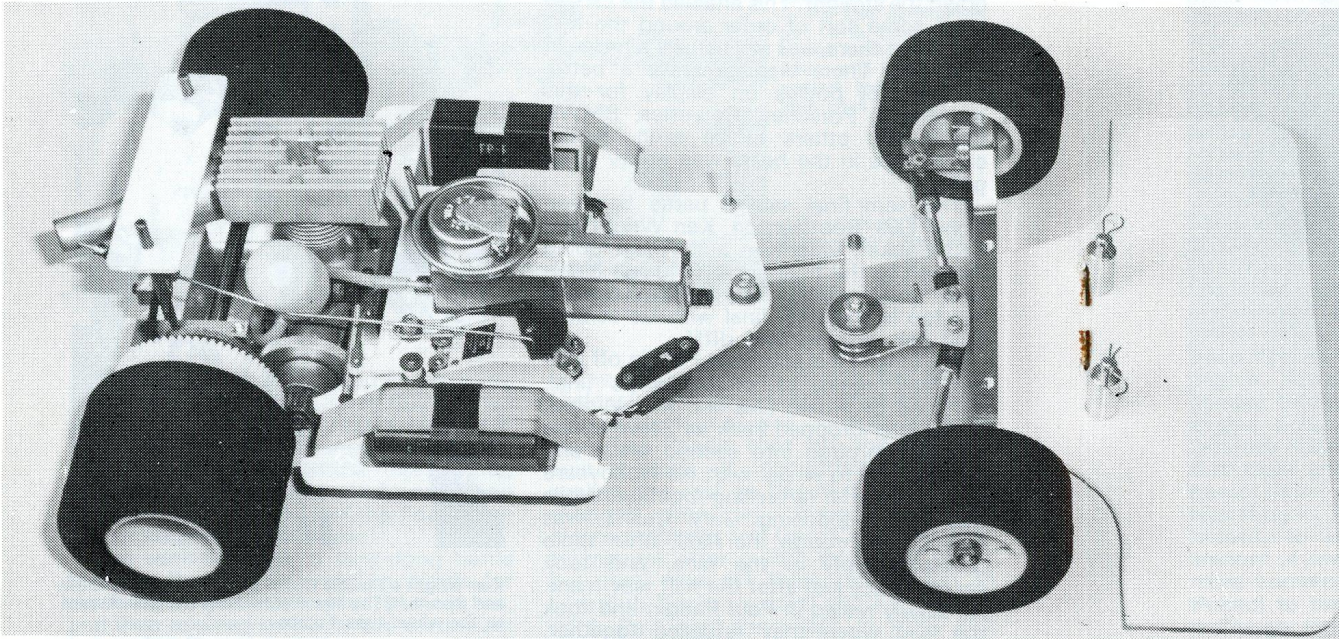

## NEW FEATURES

Aluminium Front End  
 New Servo Saver  
 Ball Joint Tie Rod  
 Fibreglass Chassis  
 Disc Brake  
 8mm Rear Axle  
 New Rear Pod Plate  
 New Gear Material  
 Plus Fuel Tank

PROTOTYPE RC200 CARS WERE USED BY WORLD CHAMPION, BUTCH KROELLS, AS WELL AS THE FIRST 7 PLACE FINISHERS AT THE WORLD CHAMPIONSHIPS.

### 1977 EUROPEAN CHAMPIONSHIPS



PER GUSTAFSSON — SWEDEN  
 SPORTS CHAMPION



UDO FRANKE SWITZERLAND  
 FORMULA CHAMPION

### 1977 USA ROAR NATIONALS



ROGER CURTIS  
 SPORTS CHAMPION



BILL JIANAS  
 G.T. CHAMPION

### 1978 BRITISH G.P.



DEBBIE PRESTON

1st BRITISH G.P. Sp/GT  
 2nd WORLD CUP MONACO  
 1st BOURNEMOUTH F/1

**ASSOCIATED** 1928 East Edinger, Santa Ana, CA. 92705, USA



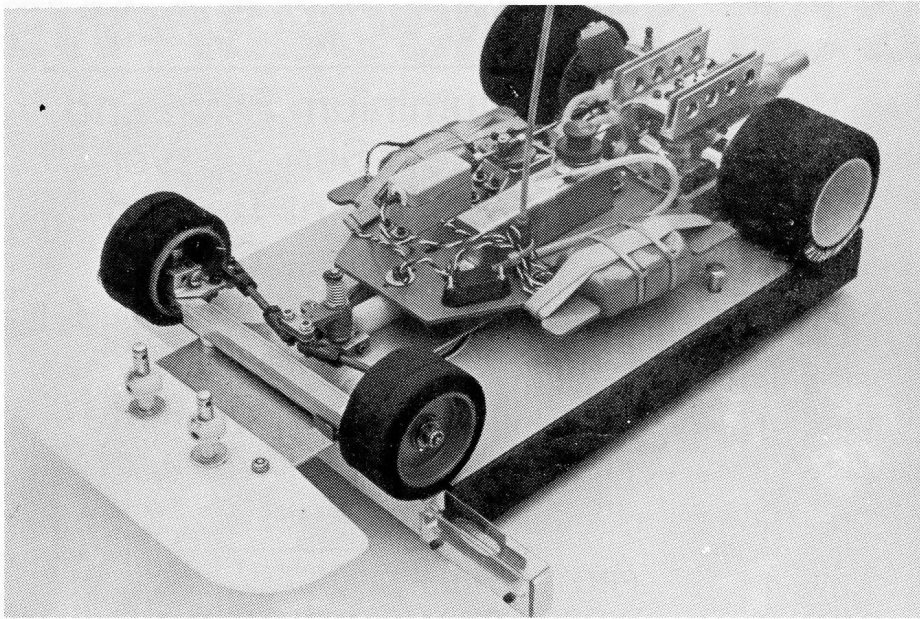

## DOING THE DELTA

"THE Campbells" have been in the r/c model car game — business? — almost since the beginning, their first catalogue appeared in 1969, and they can justly claim to be the oldest firm still going strong (one earlier firm has not lasted). Ken plus wife Gloria and Ken's brother Bill form the triumvirate, hence "Delta" the greek D forming a triangle. But we must not forget that other Delta "great" who have been driving their cars to victories over the years none other than Art Carbonnel, a legend in

his lifetime!

I was therefore specially pleased to hear from Bill, who is the research and products side with details of the company. Looking at the kit drawings provoked an immediate desire to try out a car since not many seem to be operating over here — largely I feel because much of the company's publicity is strictly word of mouth. Sight of the 760JL provided by Ted Longshaw confirmed early interest so here we are.

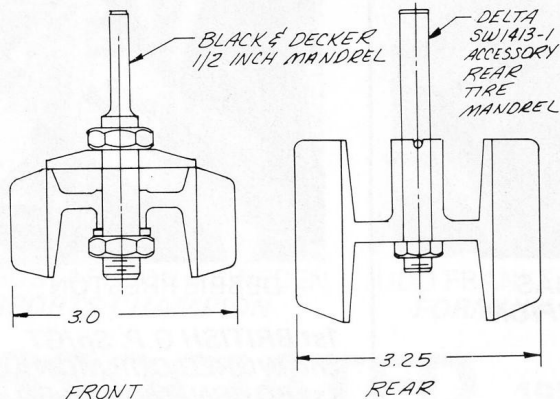

The very latest 1978 Delta on the famous Delta "tweak table." Still basically the 760JL I have made until you discover the numerous refinements.

Detail of mandrels for truing tyres. For less machine equipped people a sort through coachbolts in the junk box will probably find one to fit!

## WHAT A DIFFERENCE

Like other successful American kits Delta have followed a policy of steady improvement over the years, adding, improving or changing parts only as better could be evolved, and race testing had confirmed their views. Many accessories now in general use first had an airing in prototype form in a Delta car . . . so that some parts give one a strange feeling of *deja vue*.

Chassis plate is a single alloy plate the full length of the car. Strength and rigidity is given to the rear end by bolting on two beautifully machined side bearers described respectively as clutch hanger and engine hanger. This introduces a major difference. Recommended engine Veco 19 is **not** supported on conventional engine bearers but bolted to engine hanger through the holes retaining the engine endplate. These holes must be carefully drilled and tapped out (using NC 4-40 taper and 2nd tap; obtainable if you do not already have them from any good tool shop — Buck and Ryan for example. Indeed, to digress, anyone using any amount of American gear should have the more common tap and drill sizes in NC thread) to take 5/8in. cap screws which are longer than those retaining the engine backplate. At the same time two or three thin washers are introduced to permit some manoeuvring space for clutch bellhousing end float (about 015-030).

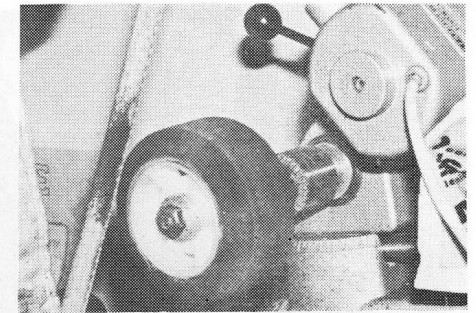

Shaping a tyre fast on the lathe using a hacksaw blade. Cover rest of lathe with a sheet — it's filthy black dust everywhere.

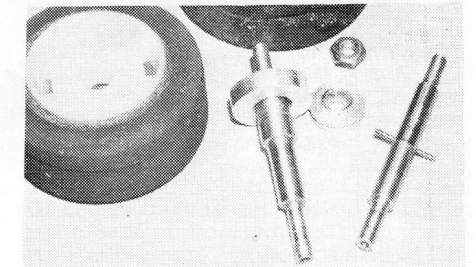

Simple mandrels turned up in a few minutes from bar. Worth making — they last until you lose them.

The beautifully machined hangers supporting engine on near side and ballbearinged clutch support on the far side. Note also ball-bearinged axles bearings and additional bar for rigidity.

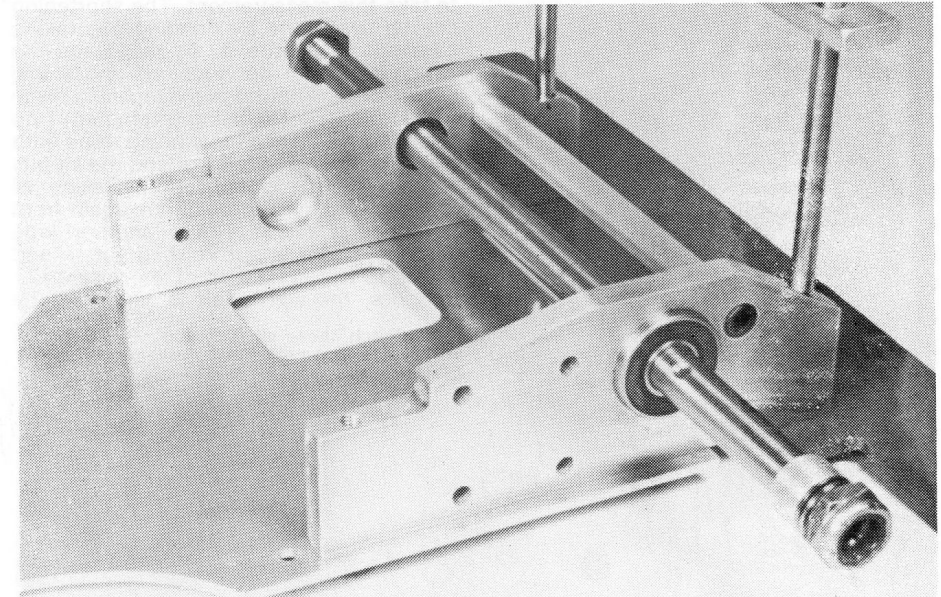



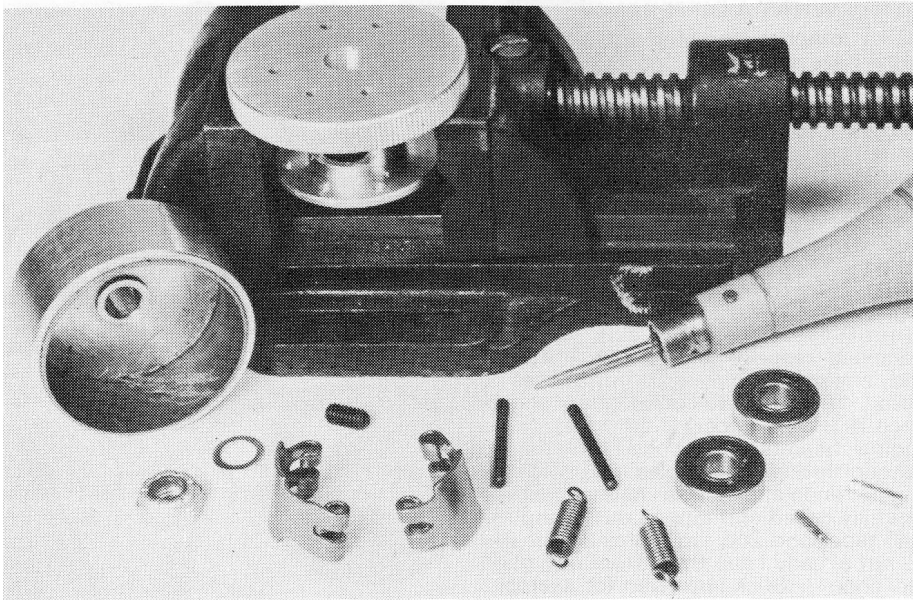

Parts for the clutch laid out with machine vice for fitting.

Left: First stage of fitting shoes.

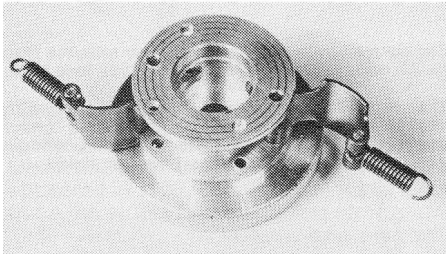

This is not the only surprise. Veco crankshaft must be shortened so that it is 11/16in. in length measuring from the bearing. The Veco tapered collet is slid off to take this measurement. The shortening can be best done by grinding off, taking care not to overdo it. At this stage the clutch parts can be examined and a trial set up made with the two hangers in place to see just what is being attempted. I do hope that all this so far is being done with plan laid out in front of you and the kit bits spread out for identification. Design of flywheel and flyweights differs again from common practice — just another little surprise! But it is not finished yet — and this is to my mind one of the nicest differences, the crankshaft is supported by

Left: Clutch shoes all tucked in. Below: Items lined up to assemble clutch, bellhousing and gear on crankshaft.

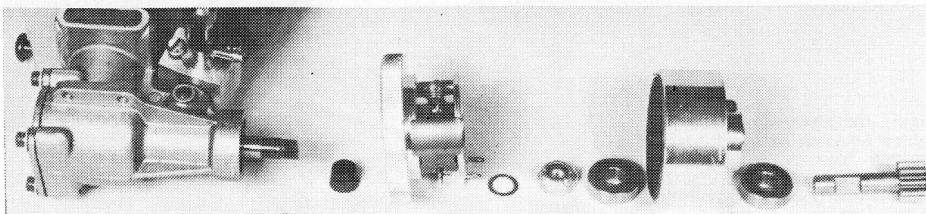
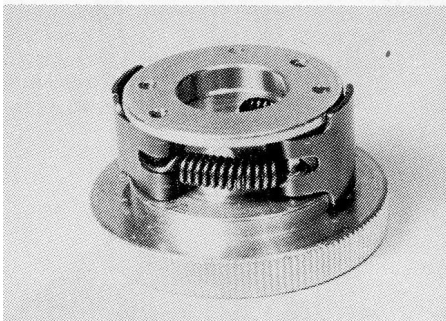

the clutch hanger. That is to say we have overcome the system by which only one end of the shaft is held — we have both ends held which must surely be a better engineering answer than any other. Always provided, of course, that the whole mounting is perfectly rigid. This explains the reason for the two side hangers. They are stout and hold that rear end vicelike, whilst still allowing enough frontal flex for the steering end.

With the aid of the little washers between engine hanger and end plate of Veco 19 some modest degree of endfloat can be arranged for the clutch bellhousing. It only needs a very little — but that little is really desirable. Once the general set up is grasped then the crankshaft can be ground down as required with every confidence.

Rear axle and clutch bearings are fitted in place and secured with Loctite. Note also the rear hanger spacer which ensures the rigid fitting of this end. Take a look at the neat brake arm. A little quiet relaxation at this stage would be to bond on the brake and clutch linings and also the tyres to the wheel hubs. Delta recommend the pregluing of hubs and tyres and then tipping in lacquer thinners. More usual is the customary spreading of Evo-stik and pushing into place without delay. This is very much a matter of personal choice. I am an Evo-stik man and follow Keith Plested's excellent method by fitting the hub on a mandrel in the lathe, turning the

headstock by hand whilst sliding on the tyre. Sticky tyre is held in plastic envelope used as a glove mitten. This is non-frustrating and keeps the hands clean. Spin the tyre round via the mandrel so that it runs true and leave to set off.

Delta even offer a special mandrel as an accessory for this desirable operation, which is followed by a certain amount of tapering off of wheels with a sanding block. However, a mandrel is so easy to make up that it is hardly worth the trouble (and expense) of acquiring a readymade one from distant parts. It takes only about ten minutes to make up a pair for front and rear wheels and they will last for ages until you lose/lend them.

Dodging now to the front end the steering can be set up. The interesting ballbearing front wheels will already have been noticed and the bbs duly installed, but gently, pressing on the outer rim of the race. Bearings are shielded and there should be no trouble with dirt working in, but remember to keep them lightly oiled. Of course there is the problem of having spare sets of front wheels all complete with ballbearings. This can be made a little lighter in two ways. First by getting some surplus bearings if possible; then by limiting raceday stocks to two spare pairs;

Front end assembled. Note robust connections and unsupported kingpins.

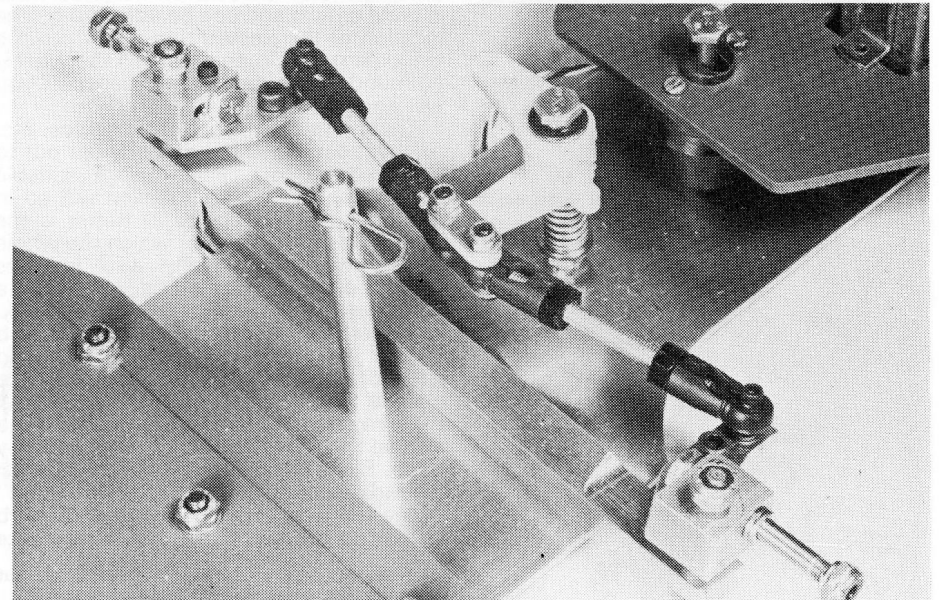



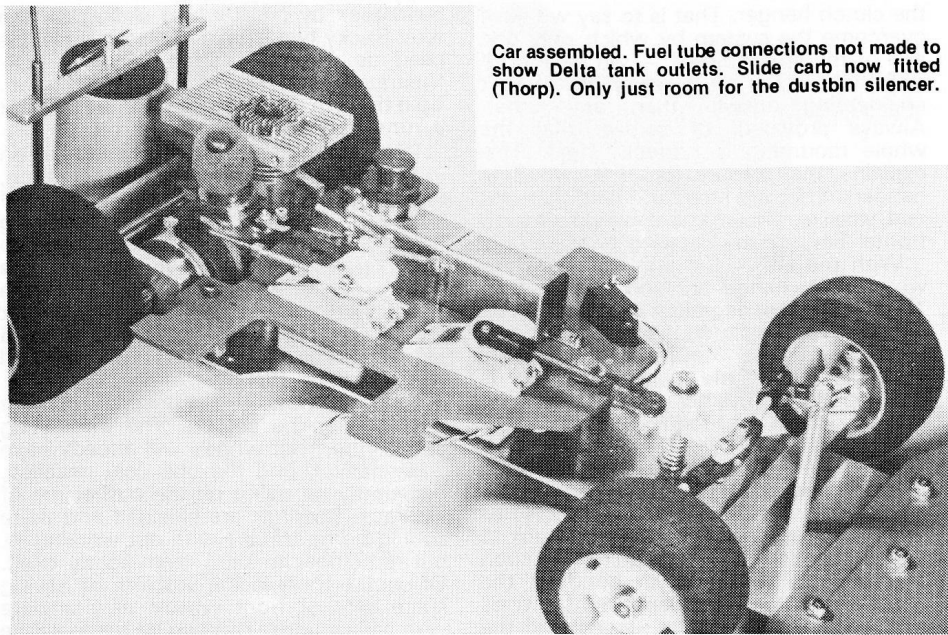

Car assembled. Fuel tube connections not made to show Delta tank outlets. Slide carb now fitted (Thorp). Only just room for the dustbin silencer.

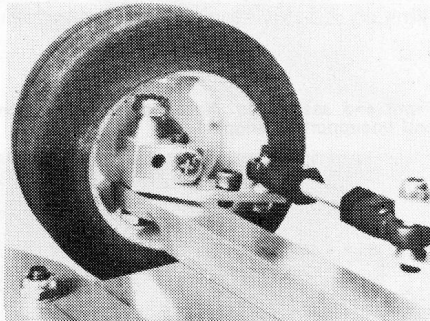

Only just room for the wheels to turn — so watch it!

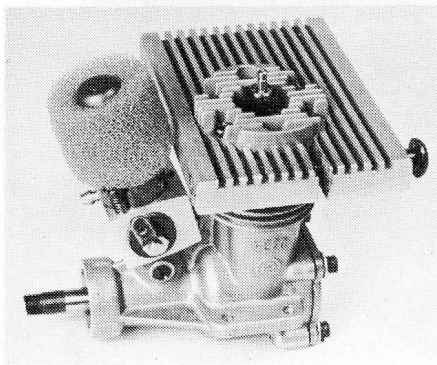

finally by having a set or two plain bearing practice wheels.

The steering crossbeam is a single piece, that is there is no upper and lower claw to hold the kingpin it rests snugly and happily on top of the beam. A short socket head cap screw acts as a steering stop each side. Clearance inside the wheel hubs is quite critical and can be adjusted by the location of the sleeves through which the kingpost runs. When all is well the wheels go round and round in utter silence — you will know when.

There remains the set-up of servos, etc. on the radio plate. This is ready cut out to take Futabas or similar and a suitable upright fuel tank. The Johnson will go in though not designed for it. Better is the special Delta fuel tank for which the whole is designed. This really also involves acquisition of a Delta slide carb including a second needle valve and pressurised tank. However, I struck a period of slide carb famine (new PB not in production and Greeno ceased production) and had to choose between an ancient very Mark 1 PB, a more elaborate arrangement to use a normal Kavan carb or a Thorp slide for my Veco. Since the servo layout is in line on the radio plate with a push for "brake on" and a pull for "engine off" a slide carb offers the neatest answer. It is not quite

First thought: Kavan carb with Delta filter, but awkward to arrange throttle movement.

Adjusting end float for bell-housing with a feeler gauge. Adjustment washer can be seen on right. Two were needed.

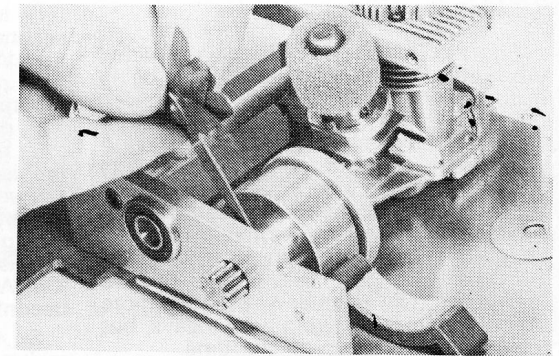

Eddie Van Nylen from Belgium had to the latest type Delta but with a great big pumper carb so went to some trouble to arrange suitable linkage. It looks complicated to me, but went very well.

the answer as I have had to block off main jet connection on fuel tank until I get the genuine Delta slide gear. Tank also has that nice spring loaded filler cap similar to the one shown on the latest SG Futura (that man Campbell thinks of all these things first!).

On/off radio switch is mounted to operate from under the plate — this is easier to switch off with the body on. There is only just room at the back for a dustbin type silencer to sit — perhaps a slightly deeper rear bumper would be a good thing but I used the whole of the part provided. It is also quite critical getting the silencer attached to engine with only

enough room to get the fuel connection clear of the fixing screw.

What else remains? Just for the record I took a picture of Belgian Delta man at the British GP who has the very latest model but has fitted a large pumper carb with inevitable complications of the connections which I have avoided. However, he may feel the added urge of the pumper worth the extra effort. I can hardly wait

Special thanks to Ted Longshaw who not only provided the kit but patiently supplied the sundry bits and pieces that I felt desirable to make a good job of it which were asked for in infuriating dribs and drabs.

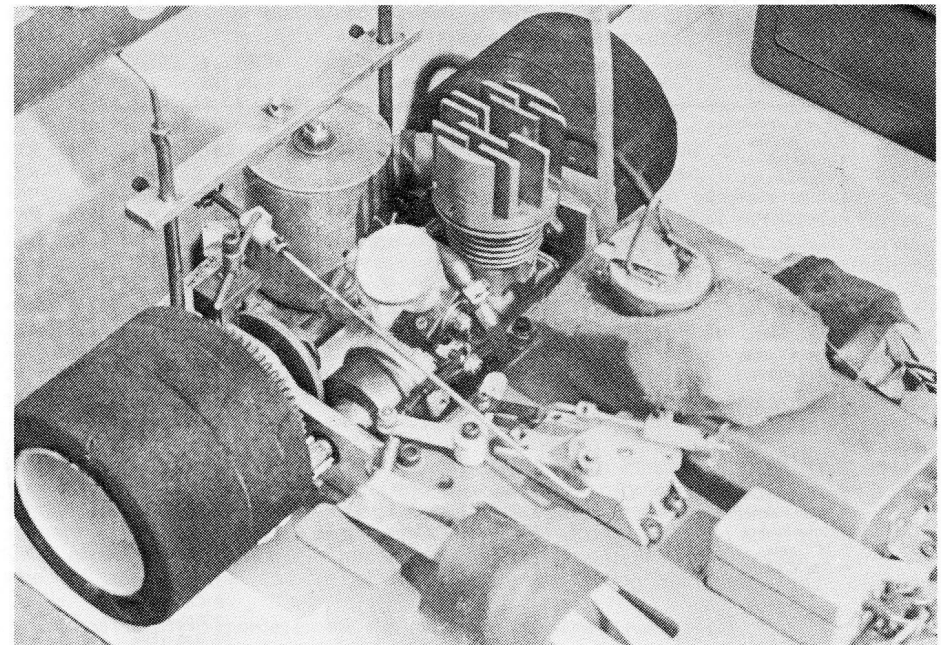



Continued from page 27

Sports/GT racing on Monday attracted the largest field, thirteen heats being necessary to fit them all in. Twelve lap times were put up with the more aerodynamic bodysells and some very close heats were fought out, due to the "grading" of heats on drivers' handicaps.

The interference problem cleared up on Monday after a strong warning from Paul Padgin on the consequences of claiming interference when it was due to driver's negligence. The weather was slightly more breezy than on the two previous days, but the sun shone down all the time.

Bob Errington got goping in the semi-final and led until his engine cut out and ended his troubled weekend. Gary Culver and Ken Wright went through to the final beating Bob Denton and hard-trying Chris White.

The 0 - 15% Handicap final looked pretty frantic from where I was and in the 20% final Paul Ekins was unlucky to have a rear tyre disintegrate when he was leading. Eventual winner was Malcolm Bartlett with Chris White literally charging into the third.

The Open Final saw Paul Padgin again lead the race from the start as on the two previous days - surely it must be a third

time lucky for him. Steve White was in second place making it a Hobbycard 1, 2. Ken Wright and Gary Culver battled for third place. Paul Padgin was really flying around and had a one lap lead after only five minutes, but disaster again struck after thirteen minutes when he lost a wire on his battery plug. With Gary Culver off as well Steve White and Ken Wright fought it out, Ken getting into the lead. Paul got going again, but broke the pinion off his clutch bell. He was finished, with Ken Wright leading by just over one lap to become a double Champion.

So that was it! A fantastic weekend's racing made possible by the Wombwell Sporting Association, Hobbycard and the officials who sat in the control tent all weekend so that everyone could have a good race meeting - they were great.

We have a new double champion in Ken Wright who won two great scraps to get there and Gary Culver as Saloon Champion. I think that Gary's race should be an example to all, he was so cool, it was incredible. Last of all, commiserations to Paul Padgin on winning none after leading all three and to everyone who went home with nothing - I hope they enjoyed themselves, perhaps learnt something and will come back to try again.

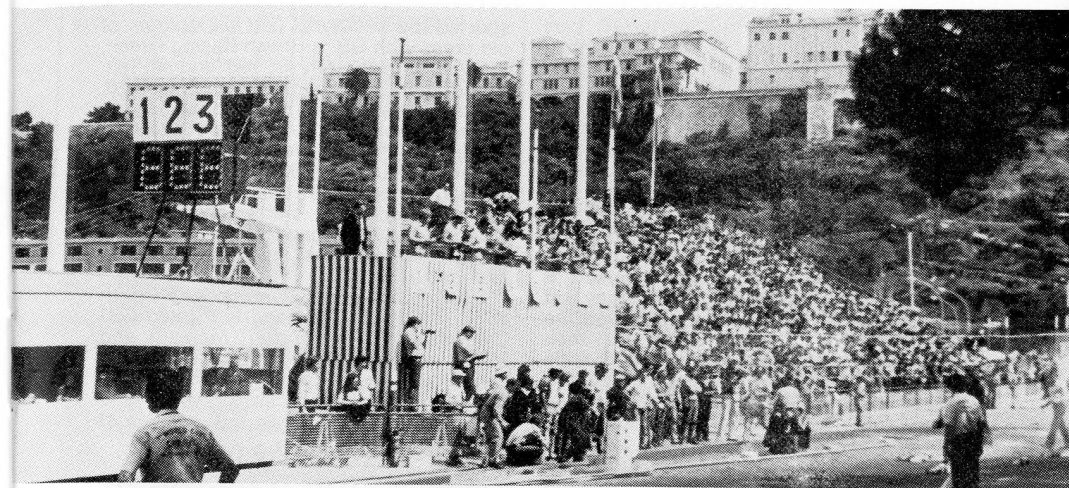

## MONACO WORLD CUP

### 1-2-3-4 GB

Undoubtedly the most adequately organised r/c model car meeting yet can be the only verdict on the 1st World Cup meeting at Monaco! With a beautiful setting, a circuit right by the harbour of Le Condamine, separated only by the elegant Prince Rainier III swimming pool, and a three storey admin. building, the organisation was of a quality to match.

The circuit is just over 210 metres long with a fantastic 88m. straight that provided a constantly recurring engine test for everyone. Width throughout is only 4m with little or no escape areas so that real concentration is demanded to achieve good times over 15 minutes heats at fantastic speeds. Marshals - all orange track-suited - were provided mainly from the sons of the organisers and younger clubmen. They did a magnificent job. Of the forth-eight invited drivers only Fiochi of Italy was absent, alas from sickness. Debbie Preston raced in place of original invitee Dave Preston, still not quite fit again, though he was to prove a splendid pitman later.

The opening days were devoted to practice runs, with heats of up to twelve drivers - no problem with both British and continental frequencies in use and a kindly Post Office. Early times were somewhat hesitant 18 or 19 secs. per lap. With growing confidence this became 16 and 17 and by the end of unofficial

practice claims of 15 secs. were being made (I believe Art Carbonnel did a 14 + lap), Dave Martin could only get away from Oxford for a couple of days and so had no practice on Thursday, arriving late in the afternoon.

On Saturday the hard work began with four timed heats each of 15 minutes, involving one or more pit stops. A torrential downpour on Friday evening had left the track still damp at the start. Somewhat horrified Americans, with little or no experience of wet running, were asking anxiously after rain tyres. Happily the rain did not continue and with a drying track the first series of heats produced figures of 49-51 by the leaders. Then in the second series of heats Phil Booth produced a magnificent 56 laps in just over the 15 minutes which was never headed throughout the day. Only Phil Greeno came within range at the very end when he also broke into 56 laps. Ronny Ton and Gabbiani of Monaco managed 55, then came Keith Plested with 54. Debbie was just in the running with 53. Best American was Gene Husting at 52.

The strong American contingent did not settle down easily to European racing. As Gene Husting remarked most of their

Start of the Final. Note crowded stands, electronic scoreboard and TV replay box.

### RESULTS FORMULA

#### Handicap Final 0 - 15%

- 1 P. Musselwhite
- 2 Ray Watson
- 3 Brian Palmer
- 4 Pete Clough
- 5 Andy Yarborough
- 6 Dave Beatty

#### SALOON

- 1 Dave Beatty
- 2 Andy Yarborough
- 3 M. Robinson
- 4 John Russel
- 5 J. Bossoms
- 6 Pete Silcock

#### SPORTS/GT

- 1 Dave Beatty
- 2 Richard Hamilton
- 3 Brian Palmer
- 4 John Parker
- 5 M. Sams
- 6 Ray Watson

#### Handicap Final 20%

- 1 Pat Angelin
- 2 Jim Harrop
- 3 Malcolm Bartlett
- 4 Mick Newman
- 5 Chris White
- 6 Fred Livesey

- 1 Fred Livesey
- 2 Paul Mason
- 3 Ted Booker
- 4 Malcolm Bartlett
- 5 Chris White
- 6 Steve Mellors

- 1 Malcolm Bartlett
- 2 Paul Ekins
- 3 Chris White
- 4 John Darrington
- 5 Pete Hutton
- 6 Pat Angelin

#### Open Final

- 1 Ken Wright
- 2 Bob Denton
- 3 Gary Culver
- 4 Ron Bates
- 5 Paul Padgin
- 6 Steve White
- 7 Ted Booker
- 8 Pete Clough
- 9 John Everatt
- 10 Chris White

- 1 Gary Culver
- 2 Paul Padgin
- 3 Pete Hutton
- 4 Steve White
- 5 Robin Ellis
- 6 Ken Wright

- 1 Ken Wright
- 2 Steve White
- 3 Chris Englefield
- 4 Gary Culver
- 5 Paul Padgin
- 6 Ron Bates
- 7 Bob Denton
- 8 Chris White
- 9 Bob Errington
- 10 Robin Ellis



running is done with Sports/GT cars which are easier to handle, and with a strange track and little room to escape things were difficult. They had all fitted PB silencers to be quite sure of not breaching our noise regulations in Europe. These were located forward on the radio trays! Reason given was to avoid weight behind the rear axle. Once or twice in heats Art Carbonnel was seen to veer out at the corners looking in vain for a board to "ride". What with jet lag, perhaps, and some difficulty getting exactly their sort of fuel mix (they are natural oil men) they just did not show. Dave Martin expressed the opinion that a major reason for their unexciting performance was their throttle set up. It was either on or off, they had virtually no neutral point, where power could be cut off to slip through the chicane. Time after time they were all hitting the botts dots and coming off line right through to the very end of the meeting.

A very special feature of the meeting was the magnificent Longines time keeping arrangements which were linked to a computer in the admin. building so that times were issued every twenty-five minutes as heats were completed all printed out on Xerox sheets so that enough were distributed for everyone of the contestants to have a copy. Crowd control was also good. Those with rights to be in the area all carried armlets stating their position: driver, mechanic, official, press and so on... this kept the unauthorised out of the pits and other unwelcome areas. Pits, by the way, were all in the form of long trestle tables marked with country to be using them, and suitably shaded against sun and even rain. An adequate snack counter kept hunger away, and the hospitality room on the first floor provided drinks to those in such need... or non alcoholic cokes to thirsty drivers. Between heats a large road or pavement type vacuum sweeper went over the circuit to keep it clear of small obstructions, stones or tyre fragments and the like.

A bright Sunday dawned with a full programme and an early start. First item was the staging of the two semi-finals of eight drivers each which comprised the sixteen fastest heat results. First four in each of these events were to go through to the final, with the unsuccessful eight to stage a further race to determine 9th to 16th places. The two eights were split up evenly amongst the times, that is 1, 3, 5, 7... etc. in one half 2, 4, 6, 8... in the other. Throughout the meeting all cars

sported the traditional national colours of old times with GB in British Racing Green, France in blue, Italy in red and so on. Some liberal interpretation was allowed, but all had to carry the national flag on their ailerons. In a concours the US colours of blue and white tastefully arranged would have won hands down. A special refinement of timing was that TV cameras recorded starts and anyone crossing the line ahead of the start was liable to be penalised one lap (this did in fact occur!)

Semi final number 1 comprised Booth (GB) Ton(NL) Stanzani(I) Pledsted(GB) Gustaffson(S) Marzocchi(I) Mares(I) and Sabbattini(I). It was very much a tussle between Ronny Ton and Phil Booth as one needle match, with a lap or so behind

Continued on Page 41

#### BEST QUALIFYING TIMES

1 GB	(3)	Booth P	056	0028
2 GB	(1)	Greeno P	056	0095
3 NL	(5)	Ton R	055	0100
4 MC	(12)	Gabbiani P	055	0128
5 GB	(4)	Pledsted K	054	0100
6 S	(11)	Olsson H O	054	0102
7 I	(15)	Sabbattini F	054	0141
8 I	(10)	Bellia G	054	0143
9 I	(13)	Marzocchi M	054	0152
10 S	(9)	Gustafsson P	053	0019
11 I	(6)	Stanzani G	053	0073
12 I	(7)	Gherisi G	053	0077
13 I	(14)	Mares M	053	0136
14 NL	(8)	Bervoets P	053	0156
15 GB	(2)	Preston D	053	0165
16 USA	(16)	Husting G	052	0123
17 D	(3)	Will K	052	0208
18 B		Tassaux D	051	0000
19 F		Nguyen R	051	0063
20 CH		Ruchat J P	051	0073
21 USA	(2)	Thorp J	051	0074
22 GB	(1)	Martin D	051	0118
23 USA		Carbonnel A	051	0121
24 I		Veronesi S	051	0129
25 CH	(2)	Zahnd A P	051	0138
26 USA		Curtis R	050	0003
27 CH		Franke U	050	0056
28 D		Knettenbrech F	050	0111
29 MC	(1)	Cozzi M	050	0155
30 D		Gunther J	049	0112
31 AS	(3)	Bester W	048	0075
32 MC	(3)	Bevacqua J L	048	0131
33 MC		Levesy J M	047	0000
34 MC		Carpinelli M	047	0040
35 GB		Longshaw T	047	0090
36 NL		Sukkel H	047	0154
37 NL	(2)	Cromberge F	046	0100
38 NL		Meyer A	045	0000
39 MC	(1)	Molinari P	044	0057
40 USA		Kroells B	043	0102
41 USA	(3)	Jionas B	043	0122
42 AS		Pretorius J	037	0000
43 F		Lemaitre J P	034	0000
44 D	(1)	Naser J	030	0000
45 CH		Muller H P	028	0000
46 L	(2)	Noel F	021	0000
47 F		Verplancke G	008	0000
48 XXX		Absent	001	0000

Figures in brackets show placings in finals and sub-finals.

## SOME CUP WINNERS

Top right: Triumphant Phil Greeno. Below: Lucky Lajoux takes a kiss in return as 2nd Debbie Preston gets her cup. No kiss for Phil Booth 3rd — just the cup. Centre right: Keith Pledsted looks highly delighted. Bottom left: Wennie Bester has something to take home to South Africa. Bottom right: Dave Martin takes Cup for winning 2nd Sub Final.



A Photoworld picture.





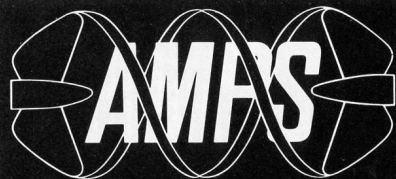

# DIFFERENTIALS AND ACCESSORIES

**1<sup>ST</sup> BRITISH GRAND PRIX (FORMULA)  
MONACO WORLD CUP  
BRITISH FORMULA CHAMPIONSHIPS  
BRITISH SPORTS GT CHAMPIONSHIPS**

We wish to congratulate Phil Greeno, Phil Booth, Ken Wright and others for their considerable achievements and help over the past months. We are pleased that we could be of assistance

**AMPS LTD. STATION HOUSE, HARTHAM LANE, HERTFORD. HERTS.**

Tel. Hertford (0992) 56597. Trade Enquiries welcome



9 THORBURY ROAD,  
UPHILL,  
WESTON-SUPER-MARE,  
BS23 4YE.

WESTON-SUPER-MARE 26265 (P.M.)

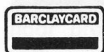

Ring Through Your Access or Barclaycard Number for Fast Mail Order Service on all R/C Car Requirements



## FULL RANGE OF P.B. KITS AND ACCESSORIES IN STOCK

International Kit **£75** — Expert Comp **£61** — Expert Std **£45** — Racing Doubles **£29** — MRP 1/12th Electrics from **£59.95** — Mardave 1/12th **£23.75** — Mardave 1/12th — Electric **£37.50** — New S.G. Futura III Kit **£72.00** inc. Free ABS Body — Your Choice — Full Range of Raydio & P.B. Tyres — K & B, S.T. OPS and Veco Engines

Special Purchase of 1/12' Tyres, 1 3/4" diam., 1 1/8" Bore — All Grades 32p pair + postage

**WE ARE DISTRIBUTORS FOR P.B. PRODUCTS AND  
RADIO TYRES — TRADE ENQUIRIES WELCOME**

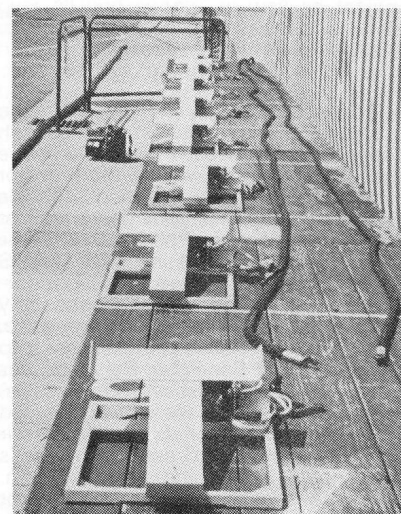

Everything for the contestant : eight pit starters laid on for the event. All designed and made by the Monaco Club.

Continued from page 38

another match between Keith and Stanzani. Per Gustafsson was never quite in the picture. The three remaining Italians failed to live up to their promise with Sabo 8th with 60 laps to the winner's (Booth) 103. Second semi which followed shortly after comprised Greeno (GB) Gabbiani(MC) Olsson(S) a young man who will need watching if he continues to improve — another Per G. in fact — Bellia(I), Ghersi(I), Bervoets(NL), Husting (USA) — the only American to make any real impression — and finally Preston (GB). Once again the race divided into two groups a leader five all in with a chance and three trailing in the shape of Gabbiani, Bellia and Olsson. Setting a fast pace Ghersi (who won over this course last year I believe) stayed ahead of Phil Greeno, with Debbie Preston and Peter Bervoets constantly pressing, so that the leader board lights were changing lap by lap. A few laps from the end Bervoets silencer broke away and he drove very cautiously to keep within the silence rules. He was not black flagged — but the organisers did want to query his placing at the end — but too late . . . he was third and entitled to his final run, with Debbie 4th a lap behind.

Throughout the day the minor finals continued for 41st to 48th place, 32nd to 40th and so on working gradually back to

Looking down the long straight on the right: the tricky chicane is on the left — lovely great botts dots!

the top qualifiers. Meanwhile the stands were beginning to fill up with patrons paying Fr15 for best stand, Fr10 for a stand looking down the track, or a Fr5 standing room along the straight. Marshals had got the hang of things beautifully, and there was some splendid yellow flagging on the straight and its approaches to deal with cars running off and getting tangled in the safety netting. T-shirts, caps, ties, programmes and a delicious smelling nut confection were all on sale around the track. David Thomas, who teaches at Caen University, was in great demand as French/English commentator, his clear French being especially welcome as a practiced broadcaster. He was also very much the right hand man of Gerard Couvreur who was doing a fine job for French model mag *Adeptes*. I did not see any other model mag rep that I knew.

Ted Longshaw suffered an unending chain of misfortunes in the minor races with broken parts — his usual bell-housing failure happened twice. The organisers even tried to squeeze him into a second race when he had failed to start in in his proper grouping — but no go. Dave Martin on the other hand, who just failed to make the top grade, showed his mettle and won his minor final, from John Thorp a lap behind.

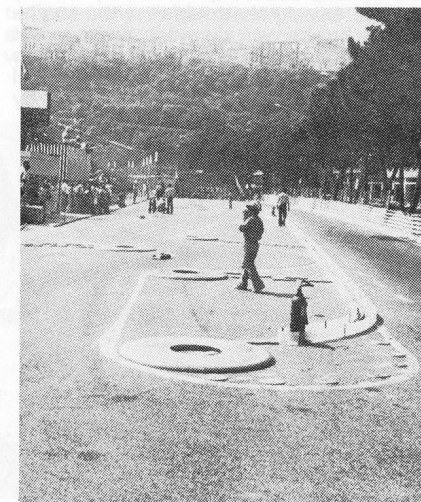



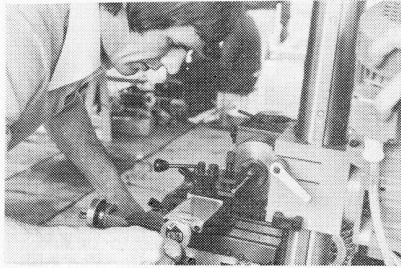

A range of lathe and machine equipment was provided by Lux the French Emco distributors — and very useful too it proved.

It was clear that the 45 minute final might well be won in the pits and there was much hard work getting their men to the post in good condition and knowing exactly how the re-fuelling calls were to be made in the heat of battle. Five stops were the least that could be expected. Martin Samuel and Ian Agnew had charge of the keyed-up Phil Greeno (Ian of course is a full-size rally driver, and responsible for the major part of the development work on the AMPS differential). Care was taken that initial fuel fill was not wasted on blipping before the start (it would be rather worse consumption over the first few laps until things warmed up). Dave P. of course pitted for Debbie; Mark Plested for Keith and Gene Husting and Jianas tackled the job of pitting for Phil Booth.

For afternoon racing the sun had moved round from the backs of the drivers to come across into their eyes so that peaked caps were almost — essential. The race started very smoothly with only Ronny Ton in any real trouble with engine failures, but he was always in the race but only as a desperate chance. Mainly it was Phil Greeno up there with an occasional nudge from Stanzani closely followed by

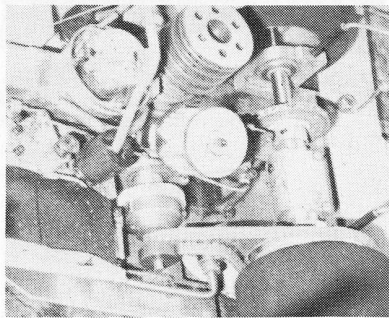

Phil Booth. Debbie played her usual game of a steady unworried race in midfield with an opportunity to sweep in when someone faltered. Keith drove well without major troubles and was well satisfied with his differential — his has spur gears against the others with bevels. Phil Booth and Phil Greeno were both running with AMPS diffs. Only Debbie P. had a straight forward rear axle, and was also the only Associated car (RC200) in the race. Greeno, Booth, Plested and Stanzani (top Italian) all had PBs. Peter Bervoets was running a Serpent, Ton and Gheris SGs. Greeno drove an OPS the rest of the field were faithful to their K & Bs. With four cars in British Racing Green driving one's own car was something of a problem. Greeno's shade of green was different enough to stand out; the others less so; Debbie had a double 8 on one side of her car which must have been a great help.

It was clear that, barring accidents, Phil Greeno was going to win as he steadily increased his lead lap by lap. It was a pleasure to watch the race, the six leading cars all running cleanly and sweetly into the deadly chicane, sliding round the top hairpin and screaming down the long straight at a real speed of something like 70 mph, braking into the corner and sliding round to complete the lap. As many remarked it was better than watching the real thing as the whole lap could be followed by eye. David's commentary got wilder and wilder as the race progressed with superlatives in both English and French... The main dicing was now between Phil Booth and Debbie who were both on the same lap, some half dozen behind Greeno; Keith P. another eight or nine away and then the bunch of Ton, Stanzani and Gheris, who was not going anything like as well as in the morning. Finally Peter Bervoets was trailing in the eighties. Then in the last few laps Debbie got into second place as Phil Greeno came over the line with 162 laps in 45 impeccable minutes of driving which represents an average lap time of 16.6 secs.

True to the traditions of Grand Prix racing a monster bottle of champagne was produced for the winner who squirted it

The famous Thorp belt-drive and the differential which has set off all the diff. demands.

over all and sundry as well as taking a modest swallow... it was only later after he had received the enormous wreathed cup that his friends decided he would benefit from cooling and threw him into the conveniently adjacent swimming pool...

Souvenir plaques and cups were presented a little later with drinks and snacks and the usual "how I might have won but didn't" from sundry less fortunate people. Each of the finalists received a somewhat smaller version of Phil's super trophy. These were all finished in silver gilt. Large but less opulent silver cups went to the various sub final winners and one went to Wennie Bester of South Africa, who with fellow countryman Johann Pretorius made an excellent showing at all stages.

As to the cars, what could one have learnt that was revolutionary? Really, just nothing: there were no real surprises, only a number of nice little touches here and there, such as the small wire loop fixed to the Americans' heatsinks which served to protect the airfoil when a car rolled, and could (in gloves) be used to lift the car. The very latest Delta was there in the hands of Art Carbonnel, and here again the numerous differences had to be pointed out as they were mainly progressive of early marques. It was nice to see John Thorp's belt-driven car in operation. It performed adequately though — as in America — not up to the highest competition standards. The diffs. came through with flying colours — it is now only a matter of how soon and how many. It was really a feast of good driving, showing just how far the art has gone in

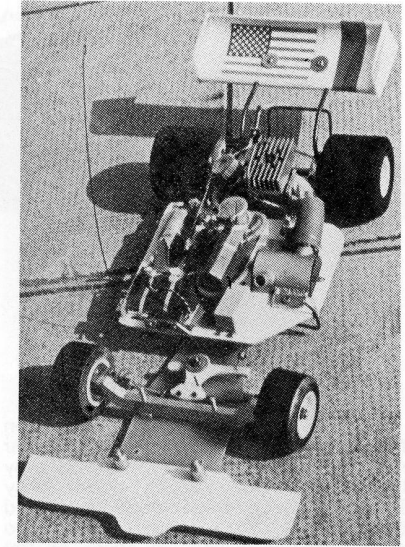

both style and tactics. I have remarked before that races can be won in the workshop, and would say without hesitation that Phil Greeno thoroughly deserved his win if only for the immense amount of work he has put in in presenting an immaculately prepared car on all occasions, and an absolute rejection of any part that could even impossibly give cause for trouble. To have a beautiful British 1 — 2 — 3 — 4 was a marvellous ending; and to have our only girl driver placed 2nd was as pleasant an icing on the cake as anyone would wish.

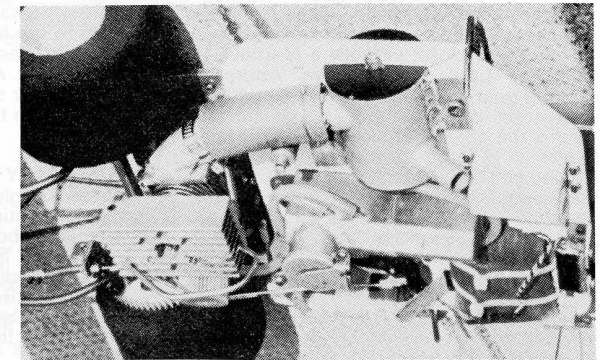

Top: Gene Husting's Associated RC200 with a cuckoo on the radio plate! Right: A close-up of that strange cuckoo in the shape of exhaust and silencer front located, allegedly to avoid getting weight behind the rear axle. Actual location of exhaust tube would have been changed had time allowed.



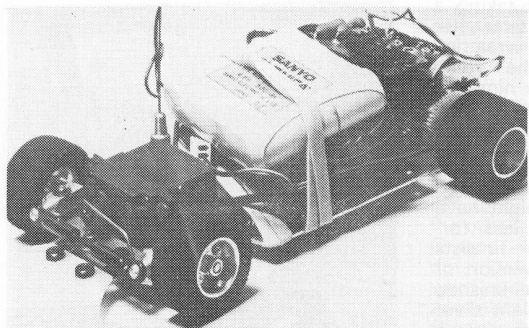

## ELECTRICS

The neat little 1/20th scale Pilot electric car mentioned in last issue's Shopping Around.

### MIDLAND ELECTRIC R.C. CAR CLUB

Following the successful Leamington Meeting at Soans' Ford dealers another meeting was organised for the Granby Halls Toy & Hobby Fair at Leicester. Ally Pally were invited but some drivers found the track width too narrow; those who stayed had a reasonable share of the places. Jeff Smith and Wes Raynor took a good lead but eventually Jeff's much modified Lectricar drew away from Wes' standard Mardave to win six laps ahead. In third place was Dave Andrew's incredible scratch-built car. Richard Gammon was best of the visitors at 9th place, Nick Adams, first of the Jerobeas, 12th and Wendy Bork 15th, leading girl.

It is hoped to run other inter-club events, so any *Electric Car Club* interested is invited to contact Secretary Tony Devenport, 200 Windmill Road, Coventry CV6 7BE (Messages can be left at Tel. Bedworth 313444).

### MIDLAND CHAMPIONSHIPS FINAL ROUNDS

Earlier rounds have already been reported. Second half of the series proved exciting and close, virtually a Mardave v. Lectricar battle, with Dave Andrews' scratch-built car intervening... with a differential of all things! The kit car still seems the general choice however. Major factor in electric car racing other than driving ability is undoubtedly tyres. Silicon treatment is the order of the day on highly polished surfaces such as at Countesthorpe College where half the rounds were run. All kinds of weird experiments were tried including epoxy glue without the hardener (it doesn't work!) Nothing better has yet been found than silicon even after several years racing in the states. Here are some results: Round 5: 1-

2-3 Mardave Geoff Labbett, Des Norton, Tony Devenport. Round 6: Dave Andrews makes it 1st, 2 — Phil Davies, Mardave, Les Pipe Mardave. Round 7: 1st Steve Talbot, Lectricar, 2nd — Wes Raynor, Mardave, 3rd — N Tony Whitehead, Mardave. Round 8: 1st Wes Raynor, 2nd — Jeff Smith, Lectricar, 3rd — Geoff Labbett, Mardave. With final round still to go Wes Raynor had the Championship already clinched, so battle was really for places. Round 9: 1st — Dave Andrews, 2nd — Wes Raynor, 3rd — Steve Talbot, Lectricar, 3rd — Tony Devenport, Mardave.

Run on total laps basis only six laps usually separated the first half dozen; all cars were running on standard motors as supplied with kits. An encouraging number of novices turned up to have a go. Large entries meant that organisation had to be sharpened up to cope with limited running time. Special thanks to Roger Wilding who obtained the Countesthorpe Hall, and to hardworking secretary Tony Devenport who helped to make the series a success.

A new Championship has been arranged to run in Spring/Summer expert races at Countesthorpe, best four of five results to count. A new scoring system will be tried, winner scoring 20pts., 2nd — 19 and so on down the scale. (Report by Alec Tricity).

### ALLY PALLY NEWS

The amazingly professional Ally Pally Newsletter continues to delight and I have no scruples about using some of their material which is deserving of the widest publicity. The club are now following the American ROAR rules for three months to see how they go. The situation may be later reviewed to suit any special British requirements.

Nick Adams Club Chairman/Editor usually has something that he has obtained for members' use, latest is a Receiver Battery Eliminator. I am using Nick's drawing and his own description of the gimmick: "Why have two sets of batteries in your car? There is no need since you can run the receiver from the main nicads using a simple electronic device. I fitted a number of these in members' cars, and they are completely reliable. The only side effect is that when the batteries are flat (6 volts) the receiver no longer functions, but then neither does the motor have any power so at least you know it's time to recharge.

What is it? Well, it's a miracle of modern space technology called the... 7805C or LM380-5.

I can get it for about £1, if you have any difficulty. You can connect them as shown below. Note that the input leads must be kept short. Also to play safe, keep the device insulated from any metal on the car in case you short out the batteries. Cover it in 5-minute epoxy as the best way of stopping the leads coming off."

Another useful comment from the next Newsletter was on motors. Who makes the fastest? Leaving aside the standard motor, this query is under test, but Nick's current verdict is Cyclone 15 Red Spot and also the cheapest at about £3.50 (I think Modelcraft can supply from Blaby).

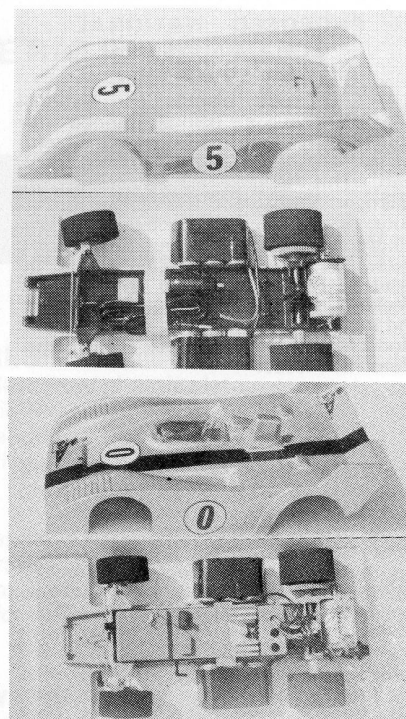

Connections for the Nick Adams battery replacement device.

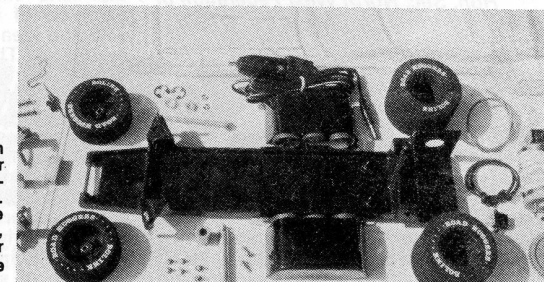
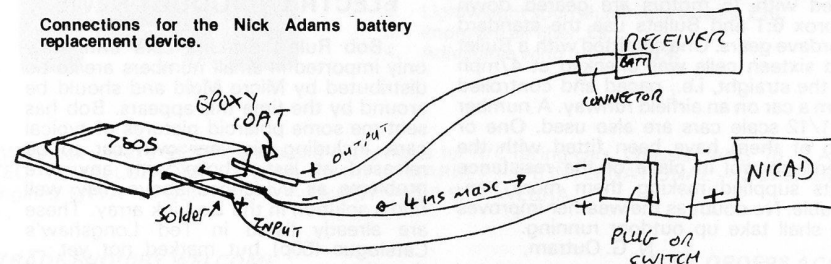

Top right: Bo-Link electric with ribbon wound speed resistor for proportional control. Below Bo-Link with electronic speed control. Bottom right: Bo-Link car for the European market with Tuffak body, Kydex plate available with or without batteries. They'll be here soon.



## PROPOSED NATIONAL CHAMPIONSHIP

### ONE DAY MEETING

A 1/12 scale electric car National Championship is being planned for Sunday October 8th at Brean Sands with the assistance of Roger Wilding of Modelcraft. This would take place in the Ballroom of the Holiday Village and include a Concours d'Elegance. Details have still to be worked out but some good prizes and some good racing should be assured. Facilities will be available for weekend stays, camping and caravans, and it is also the beginning of the second Model Makers' Holiday Week at the camp. More next issue.

## ELECTRICAL LETTERS

### One-Eighth Scale Electric in Cheshire

Dear Sir,

You may be interested to know a group of twelve to fifteen get together once a month to run indoor electric car racing. Most cars are 1/8th scale Mardaves modified to take MFA15 or MFA20 or Bullet motors generally fitted with 7 x 1.2 ah cells and home built speed controllers built round the SRC 419P chip and fitted with reverse. These controllers will handle 30 amps without trouble. Cars fitted with 15 motors are geared down approx 6:1 and Bullets use the standard Mardave gears. One car fitted with a Bullet and sixteen cells was checked at 47mph on the straight, i.e., paced and controlled from a car on an airfield runway. A number of 1/12 scale cars are also used. One or two of them have been fitted with the speed control in place of the resistance units supplied making them more handleable. No doubt as the weather improves we shall take up outdoor running.

N. G. Outram,

*Hon. Sec. North West Federation of Model Clubs.*

### Sour Grapes?

Dear Sir,

I would like to comment on Nick Adams report of 1/12 racing at Leamington, Jerobees do have a faster motor and different gear ratios, that's why they go faster: they also cost a lot more than a Mardave. He goes on to say they have an understeering nature — most racing cars

have this — it all depends on how you use it. Consequently the Jerobees spent a lot of time sliding "off line" — has Mr. A. and Co. based their driving style on Vittorio Brambilla? Meanwhile the Mardaves go round and round — I call that consistent. (To finish first you must first finish). He also adds that Jerobees required fast circuits . . . his question on should there be two formulas is answered Yes! One for those who can drive anywhere, and one for those who keep sliding off line. Then we come "Mardaves continued . . . hardly worried by lack of grip." I wonder why . . . To quote from R.C.M. & E. Straight and Level June '78 : "A big flat out circuit will quickly lose interest so try to devise an interesting circuit with lots of tricky bits as well as fast straights." I even remember Tom Martin saying: "make the corner at the end of the straight a tight one, that will sort out the champion drivers. For a final point from R.C. Model Cars on the Coming Craze the last two lines read: "Let us all be careful not to fall into the trap of 'I can afford a faster car than thou.'"

Yours

"A HAPPY TORTOISE."

*(Editor: This letter has been abridged but all the meaty bits are in).*

## ELECTRIC PRODUCT NEWS

Bob Rule's Bo-Link cars until now only imported in small numbers are to be distributed by Micro Mold and should be around by the time this appears. Bob has sent me some polaroid pictures of typical cars, including his very own car to be released at last. Those with any tyre problems as evidenced above may well find a solution in the Bo-Link array. These are already listed in Ted Longshaw's Catalogue (50p) but marked not yet — the time may now be ripe. Richard Gammon of I & D Electronics is toying with the idea — in fact well into it — of producing. There is talk that a number of new makes of electric cars will be imported in the months to come, including some of the popular 1/16 and 1/20 scale Japanese cars which they are racing so happily in Toyko and elsewhere in those parts. Certainly several people have shown that a small car can be effectively run and controlled, only problem is how far away it can be clearly seen. If we are to go in for lounge racing then size will be important and loss of sighting not matter at all.



## 1/8in. SCALE R/C RACING CAR

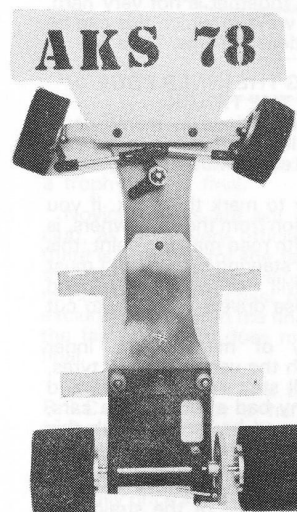
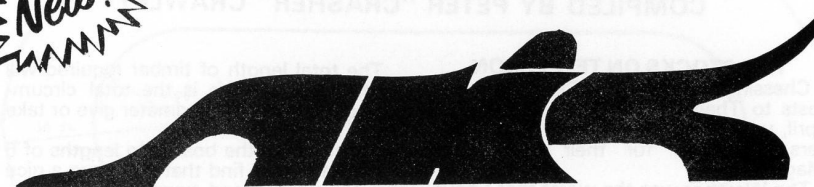

### FEATURES:

1. Fibreglass front chassis plate.
2. Split Tie-rod arrangement.
3. Black anodized aluminium parts.
4. Six ball bearings.
5. Super lightweight engine mount. Best cooling effect.
6. Spun aluminium wheels.
7. Disc brake.
8. First innovation of adapting kingpin inclination angle for better steering servo response.

### NEW available in JUNE!

1. Super Slide Valve Carb for all 3.5cc engines, **£12.**
2. Lightweight spun aluminium wheels, **£10.**
3. Improved air filter, **£3.**
4. Adjustable wing tube kits, **£4.**

We stock world's BEST car kits and equipments for R/C racing cars. Chassis : AKS '78 — ASSOCIATED — CHALLENGER — DELTA — MRP — MARKET — PB INTERNATIONAL — SUPER DASH. Engines: ENYA — FUJI — K & B — McCOY — O.P.S. — WEBRA.

TRADE ENQUIRY WELCOME

MAIL ORDERS ACCEPTED

# HOBBY WORLD

3 YUEN NGAI STREET, KOWLOON, HONG KONG





# STOCK CAR NOTES

COMPILED BY PETER "CRASHER" CRAWLEY

## R/C STOCKS ON TELEVISION

Chessington R/C Car Club were the hosts to Thames Television on the 13th April, when they came to film the Stock Cars in action for their programme 'Maggie'.

The Weather was the worst that I have ever driven in, it was raining all day from 10 in the morning until we packed up at 5.30 in the evening, but I think everyone enjoyed themselves all the same.

One of the highlights of the day was when they mounted a camera on one of the cars, and with some very careful driving by all the filming began, with a few little problems to start with, but with I hope a very good result.

This programme will be released about August time, so keep your eyes on the T.V. so as you don't miss it.

The Fullsize Stock Cars were also in attendance at this event, and again with some very clever filming.

I personally cannot wait to see the finished programme as a lot of work went into it, despite the terrible weather.

## AN OUTER TRACK SURROUND

This is a must, if you don't want a claim made against your club for injuries caused by cars taking off from the track into spectators.

The first steps in providing an outer track barrier is to go to your local tyre dealers and obtain some worn out tyres, a lot of these will be needed unless you are lucky enough to have a pair of bolt croppers, then you are able to cut the tyres in half.

With this method you are left with a big problem, a large pile of old tyres, which, without storage space on site, means someone having to move them every meeting to a storage area where they will not be a nuisance as a pile of old tyres is not a very wonderful sight.

This now brings me onto a better track surround. Although a little cost is involved it is a far better and safer method of keeping cars inside the track area.

All that is required is plenty of 4 inch minimum high timber, the thickness is up to the individual, I recommend 1 inch thick timber as this will last a lot longer although I have seen ½ inch toughened hardboard used but the replacement rate of boards was very high.

The total length of timber required will be 156 feet, as this is the total circumference of the outer perimeter give or take a few inches.

Constructing the boards to lengths of 6 feet, one should find that these are a nice size for storage and transporting.

Joining them together is not very hard, there are many ways in which this can be done for a few ideas see Figs. 1 and 2.

## MARKING THE INNER EDGE OF THE TRACK

This also can be done in many ways, some ways resulting in damage to the cars steering servo, even with a servo saver fitted.

The best way to mark the track, if you can get permission from the site owners, is to paint a line with road marking paint, this will not damage steering servos but I must admit that it will not be a very good deterrent to those drivers who like to cut corners.

Another way of marking the inner perimeter is with the use of the old tyres, this method will stop corner cutting and will not have any bad effect on the cars, only the bend need be marked with this method as should a driver wish to use the centre of the track at any time, then they would not have to worry about avoiding old tyres in the middle of the straight.

Yet another method is with the use of timber, this time the timber is laid flat on the track, although this method will require some time to be spent on it with regards to bending the timber to an oval shape and making up a few connecting pieces.

These were only a few ideas as to how to mark out the track, they all have things for them and against them, it is really up to the club's own choice . . .

## HAYWARDS HEATH R/C STOCK CAR CLUB

Formerly the Crawley-Wood Radio Stock Car Club, has now been running for over two years and boasts a membership of 30. This club only caters for Stock cars and is now opening its doors to the Hot Rod scene.

The Club meets every Sunday Morning in a car park in Haywards Heath from 10.30 until 12.45 for practice sessions. At least once a month they hold official race

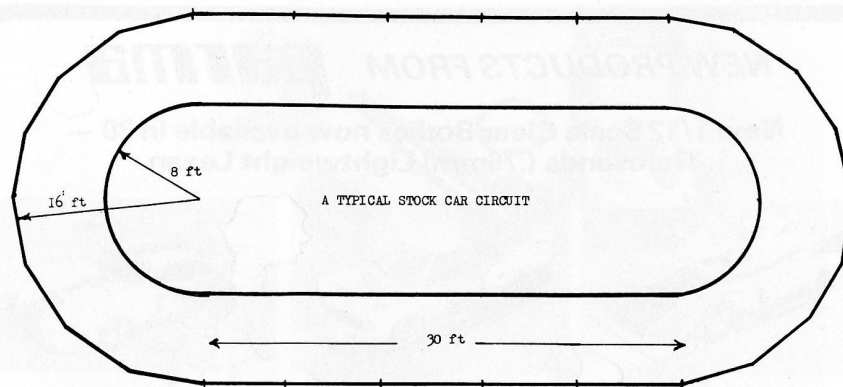

meetings, with the first 3 drivers receiving a trophy in the final.

Novice drivers are not left out in this club, as with every official race meeting there is a trophy for the fastest novice of the day, the trophy being won by the novice with the highest number of laps excluding the laps in the final, but normally the fastest novice does make it into the final.

The grading system is the same as the R.S.C.A. but with a handicap for the higher graded drivers when they are in their qualifying heats.

The Club also meets on a Monday night normally once a month at a local hotel just behind the race track, where members can pick one another's brains as to how the best can be got out of ones car; also at these evening meets they watch films of the fullsize cars in action, whilst having a swift half or pint.

All members of the club are insured for third party liability by the Club, and every year the Club goes to the model exhibition, where the club pays for those going to it. The Haywards Heath Club is the home track of Crasher Crawley and also the site of the Sussex Championship.

The Club has now joined the R.S.C.A. and will be holding open meetings for R.S.C.A. members in the near future.

The Haywards Heath Club always have an open door for new members be they Star Grade or Novice, those wishing to know more should contact:—

The Secretary, c/o. 16 Turners Mill Road, Haywards Heath, Sussex. RH16 1NN. Sending a stamped addressed envelope for reply.

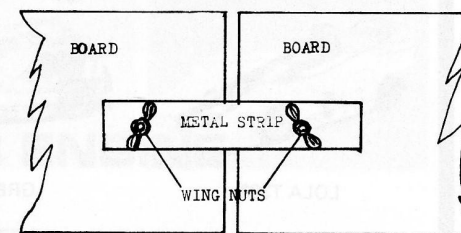

FIG.1.

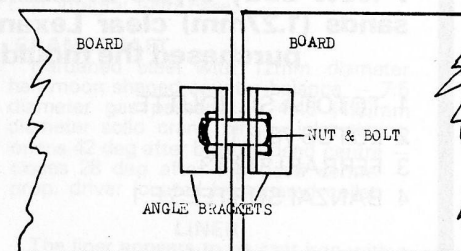
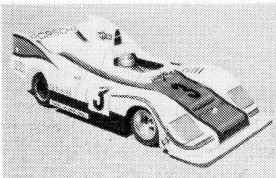

FIG.2.



## NEW PRODUCTS FROM **parma**

New 1/12 Scale Clear Bodies now available in 30 — Thousands (.76mm) Lightweight Lexan



PORSCHE 936



BMW 320 I

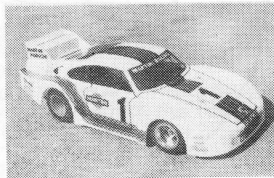

PORSCHE 935-77



LOLA T333

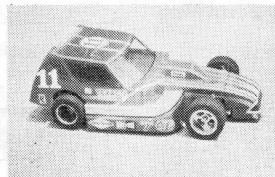

GREMLIN

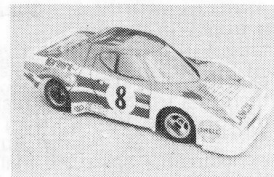

LANCIA

Coming in 1/12 Scale — Capri Silhouette — BMW M-1

**7 New body styles available in 1/8 scale. All are 50 thousands (1.27mm) clear Lexan, formed perfectly. We have purchased the moulds from "Banzai Bodies"**

- |                      |                            |
|----------------------|----------------------------|
| 1 TOTOTA SILHOUTTE   | 5 BANZAI FERRARI 512 COUPE |
| 2 LOTUS 78 F.1       | 6 BANZAI LOLA T310 SPORTS  |
| 3 FERRARI 312 T3     | 7 BANZAI PARNELLI INDY     |
| 4 BANZAI SURTEES F.1 |                            |

COMING IN 1/8 SCALE — BMW 320 I — BMW M-1

*If Parma bodies are not available in your area, please send us your favourite hobby shops address*

**parma**  
INTERNATIONAL INC.

13927 PROGRESS PARKWAY  
NORTH ROYALTON OHIO 44133 USA

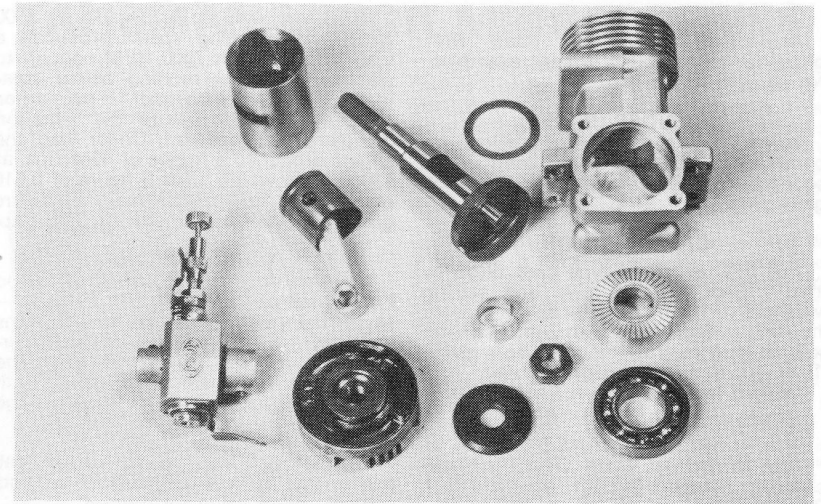

## FUJI 19-IV-SBB ENGINE

### TEST CONDUCTED BY FRED LIVESEY

THE introduction of the new family of Schnurle Ported engines brought an inevitable price increase to £40 — £50, and the Veco 19 at £25 seemed a thing of the past.

Even newcomers to the hobby are having to use the more powerful engines — so the introduction of the FUJI 19 Schnurle Ported engine at £26 seems quite a bonus for car beginners, i.e., reasonable price and Schnurle ported power.

#### ENGINE TYPE

19-IV-Schnurle Ball Bearing-Front Induction-Glow engine with Inner By-pass Porting (the ports are placed internal on the liner rather than in the crank-case). Bore — 16mm — Stroke 16mm — Displacement 3.21cc.

#### CRANKCASE

Die-cast aluminium alloy crankcase with separate front housing held by four socket cap screws — located by 24mm O/D x 12mm bore rear bearing — front bearing

16.75mm O/D x 9.0mm bore — back plate cast integral with case.

#### CRANKSHAFT

Hardened steel with 12mm diameter half-moon shaped counter balance — 7.5 diameter gas passage — 4.46 (4.5)mm diameter solid crank pin — inlet timing opens 42 deg after bottom dead centre — closes 28 deg after top dead centre — prop. driver located by tapered collet.

#### LINER

The liner appears to be cast iron with a thickness of 2.5mm to accommodate the transfer ports which are milled up the inside of the liner. Exhaust port duration is 140deg. — transfer port duration is 124deg. — liner has no top flange but is clamped between the cylinder head and a location flange in the crankcase.

#### PISTON

Hardened steel with oil groove — hollow gudgeon pin held in piston by circlips.



### CONNECTING ROD

Aluminium forging — fitted with phosphor-bronze bush in later examples. No oil hole in big end.

### CYLINDER HEAD

Black finned aluminium alloy — combustion chamber has 2mm wide squish band — brass insert fitted to accept glow plug.

### CARBURETTOR

Fuji R/C air bleed type carb fitted by two Phillips head screws and sealing washers — 12mm diameter spigot in front housing — 5mm bore with 2mm diameter x 2mm long jet protruding into bore giving 15.64 sq. mm. cross sectional area.

Weight less silencer — 7.5oz.

### PERFORMANCE

Test carried out using 'Dust Bin' type silencer, flywheel weight equivalent of 2oz.

After initial running in on 30% castor oil 70% methanol fuel mixture, a change was made to 20% Castor oil, 15% nitro-methane 65% methanol mixture. Engine started easily.

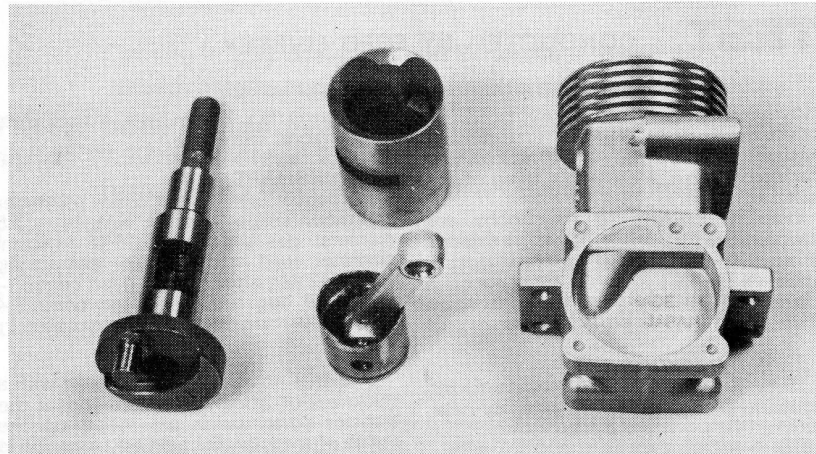

Tick-over could be set steadily at 3500 RPM — increasing speed produced a vibration period at 7500 RPM enough to unscrew the slow running screw completely from the carburettor — passing on up the revolution range the vibration completely disappeared. Under load the engine produced a torque of 40oz./ins. at 13000 RPM which gives a figure of 0.516 bhp, and is comparable with the figure given by the manufacturer of 0.55 bhp.

### CONCLUSIONS

Much more power could be obtained I'm sure with a change of carburettor to — say — 8mm bore. The inlet timing seems very short in these days of high performance Schnurle engines and the closing point is particularly early. With mods this engine could be made to go quite quickly — Cheap mods at that.

In conclusion it is only fair to say that this engine is well engineered — and certainly good value for money.

It is supplied with a detailed instruction sheet (albeit for the aircraft boys) and some quite useful information for the beginner in R/C cars.

## TALISMAN & DIGIT MIDGET SERIES

Some of our customers say we don't emphasise the features that make our system the best value for money. (1) It's expandable — up to a max. of 6 channels at £8.80 a channel. (2) Low current drain — "low power" TTL ics in decoder. (3) Choice of drycell or DEACs (4) Choice of servo mechanics... and lots more good points.

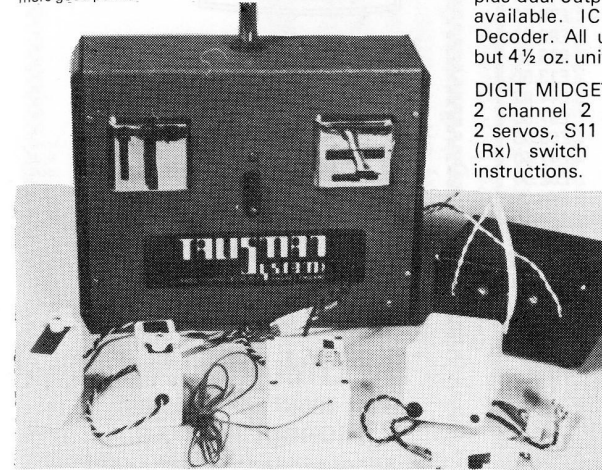

TALISMAN SERIES — All Nicad Outfit: 2 channels twin axis sticks, 2 servos, S11 or Dunham D.1. 12v DEACs in Tx, plug in Xtlas (one pair provided) either 200 or 500 M.A.H. receiver battery packs plus dual output charger, servo clips or trays where available. IC Receiver incorporating Cosmos Decoder. All up weight 8 3/4 ozs. in standard form but 4 1/2 oz. unit available.

DIGIT MIDGET SERIES — All Dry or part drycell: 2 channel 2 stick Transmitter, receiver/decoder, 2 servos, S11 or Dunham D.1 dry cell battery box (Rx) switch harness, mounting hardware and instructions.

Prices: TALISMAN SERIES as above **£80.43** inc. VAT.  
DIGIT MIDGET series as above **£56.19** inc. VAT  
SAE with enquiries please.  
Visitors by appointment please.



**WORLD ENGINES**

97 TUDOR AVENUE  
WATFORD HERTS.  
Tel. WATFORD 42859

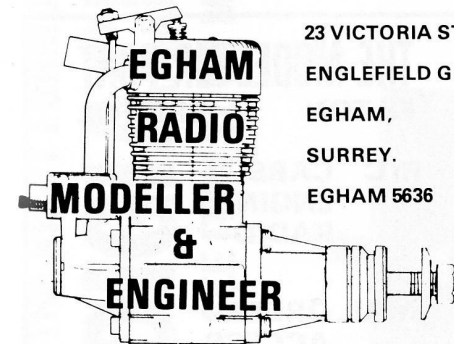

23 VICTORIA STREET,  
ENGLEFIELD GREEN,  
EGHAM,  
SURREY.  
EGHAM 5636

### ★ EASY PARKING ★

#### Second Hand Cars

RC100 — Disc Brake, Tank, Black Anodised Chassis Never raced. . . . . **£60.00**

Marker, Associated, P.B. Special — Disc Brake, all Ballraced . . . . . **£40.00**

1/8 Scale Electric Mini, Nicads etc. . . . . **£35.00**

1/12 Scale Mardave . . . . . **£30.00**

#### SECOND HAND ENGINES

K & B21 . . . . . **£30**

Veco 19 . . . . . **£14**

K & B21 . . . . . **£25**

CARS	ENGINES
P.B. International . . . . . <b>£75.00</b>	Veco 19 . . . . . <b>£23.00</b>
P.B. Expert Comp. . . . . <b>£61.38</b>	S.Tigre x21 . . . . . <b>£44.50</b>
P.B. Expert Std. . . . . <b>£45.00</b>	HB20 . . . . . <b>£24.50</b>
Associated RC100 . . . . . <b>£80.00</b>	K & B 21 . . . . . <b>£47.50</b>
Associated RC1 . . . . . <b>£55.00</b>	A/Webra 20 . . . . . <b>£38.50</b>
Associated RC2 . . . . . <b>£32.00</b>	Enya XF19 . . . . . <b>£33.90</b>

KO AND FUTABA RADIO. FANTASTIC SELECTION OF RACE TYRE COMPOUNDS.

H.P. ARRANGED  
IF REQUIRED

ACCESS  
HOBBYCARD

OPEN MONDAY — SATURDAY (9.30-6.00)  
LATE NIGHTS MONDAY & FRIDAY (8.00)



## MRM FOR CARS

### EVERYTHING FOR THE CAR ENTHUSIAST

Mardave full range	£23.75
PB Junior	£35.67
PB International	£75.00
Assos. RC 100	£83.00
SG Comp.	£66.00
Parma 1/8 bodies	£13.50
Lectricar	£44.87
Mardave Electric	£37.50
Sanwa Porsche	£69.95
Speedbuilt Contach LP400	£47.50
Speedbuilt Ferrari Boxer	£52.50
Tamiya Combat Vehicle	£44.00

Plus full range of engines, spares and accessories including Flip-Top Fuelers, Crap-Traps and that dreaded green chassis that helps win gongs and cups and things

Closed Thursdays

Enquiries must have a stamped addressed envelope

### MAIDENHEAD RADIO MODELS

55 QUEEN STREET, MAIDENHEAD,  
BERKSHIRE. TEL. 37295

## MICHAEL'S MODELS

646-648 High Road,  
N. Finchley, N12 0NL  
Telephone: 01-445-6531

**CAR KITS** by Mardave, P.B., Ke'Jon, Lectricar.

**ENGINES** by Super Tigre, O.P.S., K&B, Veco, Enya.

P.B. International Kit **£75.00**

K&B 21 R/C **£47.50**

**P.B. Heatsink** head for K&B, Veco **£7.50**

**Lectricar** with proportional speed control, Porsche 911, Escort, Porsche 936 **£44.87**

Full range of spares. Send S.A.E. for list of Kits, Engines.

Phone your Credit Card Number for same day service. Access, Barclaycard, Carte Bleu, Eurocard, Mastercharge, Visa, Bank America Card



*Isn't the Best worth just a few more Quid, Marks, Gulden, francs, Dollars, Lira, etc????*

## Thinking Electric Think Bo Link!!

Available in Europe

Write for name of nearest distributor  
Catalogue available: Send £1 for postage

### Bo Link Industries

Box 80653 — ATALANTA,  
GEORGIA 30366 U.S.A.

## THE MODEL AIR-PORT FILTON BRISTOL

R/C CARS  
ENGINES  
RADIO

MAIL ORDER  
ACCESS  
BARCLAYCARD  
HOBBYCARD

EXIT 16 — M5 Five Minutes  
Closed Wednesday

134 GLOUCESTER ROAD NORTH  
FILTON, BRISTOL TEL: 694541

# THE RIGHT FORMULA FOR YOUR CAR! DIGIACE KO V2 SEE IT IN YOUR MODEL SHOP NOW

### SPECIAL FEATURES

High Power High Speed Servos  
5lbs. Pull at 1/2 inch Radius. 0.3 Sec/70 Deg  
Tx & Rx Tuned for Operation at 10 KHz  
Dual Neutral Facility on Throttle/Elevator  
Adjustable Length Control Sticks  
Standard Size Lightweight Tx  
Large Tx Meter

**£68.00** Inc. VAT Standard Servos

**£71.00** Inc. VAT Ball Bearing Servos

OPTIONS 225 or 450 mA Nicad & Switch Harness **£12.50**  
Charger 110 or 240v **£9.00**

Northern Distributors

**C. I. & R. A. THOMPSON** (Kits & Accessories)  
132 SLAITHWAITE ROAD,  
MELTHAM, WEST YORKS. HD7 3PW  
Huddersfield (0484) 851433

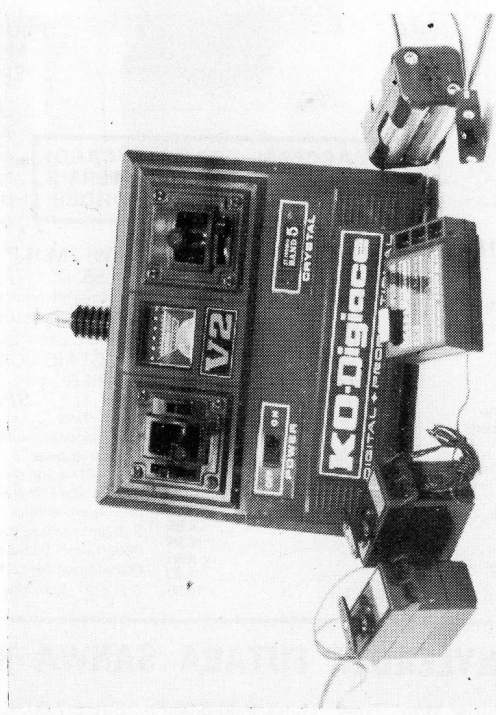

Importers and Concessionaires

**FLIGHT LINK CONTROL LTD**  
BRISTOW WORKS, BRISTOW ROAD,  
HOUNSLOW, MIDDLESEX.  
01-570-4065 (24 hour ansaphone)

TELEPHONES





9 Village Way East, Rayners Lane, Harrow, Middx. Tel. 01-8667770

## R.C. CARS

	£	p
P.B. International	75.00	
P.B. Expert Comp	61.38	
P.B. Expert STD	45.04	
P.B. Dual	29.18	
S.G. Comp	66.72	
S.G. Professional	124.55	
Associated RC100	89.95	
Associated RC1	59.90	
Associated RC2	34.95	
Mardave Formula	23.75	
Mardave Saloon	23.75	
Mardave Stock car	23.75	
Ke'jon Stock car	29.50	

**PLUS** A large stock of R.C. car spares always in stock including P.B. Associated, S.G., etc.

*All prices correct at time of going to press but subject to alteration.*

## R.C. ENGINES

*Just arrived:*

Super Tigre X21 ABC car	44.57
Veco 19 inc sil	24.50
HB 20 inc sil	24.50
Super Tigre 19 ABC car	36.50
K & B 21	47.50
OS 20 inc sil	25.97

**ALSO** Veco/McCoy conversion parts, including chrome piston/liner assembly, stoker crank-shafts, and High comp heads, etc. Send S.A.E. for price list.



**ACCESS! BARCLAYCARD! HOBBYCARD! H.P. TERMS PLUS FAST MAIL ORDER.**

## TUNE UP ACCESSORIES

### SILENCERS

	£	p
Semco Car	6.95	
Semco Car (adapter Veco 19)	1.95	
Preston Car Sil	7.95	
S.G. Car Sil	7.50	

### TANKS

PB Quick Fill (4 oz.)	2.12
Assoc. Metal Tank Kit	1.95
Assoc. Chicken Hopper Comp	11.55
New GP Racing Tank (Sumped)	7.50

### PB RACING HEADS

Veco/McCoy	7.50
ST 19	7.50
ST 21	7.50
PB Piston Slide Carb 3/8th in. or 7/16th in. Spigot	14.00
Perry 40 Carb.	6.95
Perry 61 Carb.	6.95
HB 20/Veco 19 Heat Sink Head	4.50
PB Heat Sink only	1.95
New GP Slide Carb for K & B 21, OPS 21, ST X21	16.50

## MONACO WORLD CUP

**This is the Cup! All the items in the winning car can be obtained in the shop.**

**Appreciative thanks to Pitmen Martin Samuel and Ian Agnew**

### RADIO

Futaba medallion 2FD 22m servos	69.75
Futaba medallion 2 'brick'	66.75
Futaba twinstick 2 FD 17m servos (dry)	93.00
Futaba steering wheel '2' FD 17m servos (dry)	93.00
Sanwa mini 2 drycell	54.95
Sanwa standard 2 drycell	79.95
MacGregor 2 drycell	61.00
Futaba FD 17m servo (waterproof)	20.50
Nicad conversion for above always in stock.	

**PLUS** Full range of Futaba, MacGregor, Sanwa and Skyleader Radio.

### Just Arrived! New!!!

AMPS Differential unit complete with rear mounting blocks and bearings, disc. Ready to fit to PB International . . . **£42.95**

**NEW! M.R.P. Jerobee r/c electric, £59.95.**

Lectricar with prop. speed control . . . **£44.87**  
Also large stock of BO-LINK, JOMAC, JEROBEE, ELECTRO CRAFT 1/12th ELECTRIC CAR KITS AND ACCESSORIES.

### SPECIAL ITEMS

P.B. Air filter	£1.50
S.G. racing tank with sump	£6.95
S.G. servo saver	£2.95
S.G. X.21/racing sil. -80db	£7.50
S.G. Futaba 17m side servo mount	90p
S.G. Alum. air filter	£1.95
Sullivan crap trap fuel filter	85p
Robart super pumper	£11.95
Perry 61 pumper carb	£7.95
O.P. S.21 car engine	£39.95

*specialists in*

# SKYLEADER FUTABA SANWA MacGREGOR

Opening hours: Mon., Tues., Thurs. 9.30-6.00 Fri., Sat. 9-7.00. Closed all day Wed.